

# TECHNICAL MANUAL



**DAT 400** Weight indicator/transmitter

Software version PWI3081



# TABLE OF CONTENTS

PRECAUTIONS .....	Page 2
INTRODUCTION .....	Page 3
TECHNICAL FEATURES .....	Page 4
INSTALLATION .....	Page 5
FRONT PANEL OF THE INSTRUMENT .....	Page 11
USING THE KEYBOARD .....	Page 12
INFO DISPLAY .....	Page 14
VIEWING, ZEROING THE WEIGHT AND AUTOTARE.....	Page 15
SETTING.....	Page 19
DIAGRAM OF THE MENU .....	Page 21
SETTING PARAMETERS.....	Page 23
CALIBRATION.....	Page 26
WEIGHING PARAMETERS .....	Page 28
INPUT/OUTPUT PARAMETERS.....	Page 30
SERIAL OUTPUT PARAMETERS.....	Page 33
ANALOG PARAMETERS .....	Page 37
SERIAL COMMUNICATION PROTOCOLS .....	Page 39
USB CONNECTION BETWEEN DAT 400 AND PC.....	Page 48
FIELDBUS PROTOCOLS .....	Page 52
TROUBLESHOOTING .....	Page 66

## PRECAUTIONS

READ this manual BEFORE operating or servicing the instrument.

FOLLOW these instructions carefully.

SAVE this manual for future use.



### CAUTION

The installation and maintenance of this instrument must be allowed to qualified personnel only.

Be careful when you perform inspections, testing and adjustment with the instrument on.

Perform the electrical connections in the absence of the power supply

Failure to observe these precautions may be dangerous.

DO NOT allow untrained personnel to work, clean, inspect, repair or tamper with this instrument.

# INTRODUCTION

The DAT 400 is a transmitter of weight to be combined with the load cells to detect the weight in every situation.

The module is easy to install and can be mounted on 35 mm DIN rail.

The display allows easy reading of the weight, the status of the instrument, the setting parameters and errors.

The 4 keys located below the display allow the operator to perform the functions of ZERO, TARE, GROSS/NET switching, setting of the setpoints weight, setting and tare both theoretical than real.

The DAT 400 uses the serial port RS232 with ASCII and Modbus RTU protocols for connecting to a PC, PLC and remote units. In parallel with the RS232, a USB port available.

They are always available 2 programmable weight setpoints and the control of the maximum weight value reached (peak).

The RS422/RS485 serial output allows you to connect up to 32 addressable devices.

The availability of the most common fieldbuses, as an alternative to the RS422/RS485 port, also allows the transmitter to interface with any supervision device currently offered by the market.

Available versions:

DAT 400: weight transmitter with serial output RS232 (USB), RS485 and Peak function. Supported protocols are Modbus RTU, continuous, slave and the ones upon request. Two programmable setpoints, 2 inputs and Peak function.

- **DAT 400/A:** version with the analog output.
- **DAT 400/PROFIBUS:** weight transmitter with serial output RS232 and PROFIBUS DP.
- **DAT 400/DEVICENET:** weight transmitter with serial output RS232 and DEVICENET.
- **DAT 400/CANOPEN:** weight transmitter with serial output RS232 and CANOPEN.
- **DAT 400/PROFINET:** weight transmitter with serial output RS232 and PROFINET.
- **DAT 400/ETHERNET:** weight transmitter with serial output RS232 and ETHERNET.
- **DAT 400/ETHERNET IP:** weight transmitter with serial output RS232 and ETHERNET IP.

## IDENTIFICATION PLATE OF THE INSTRUMENT

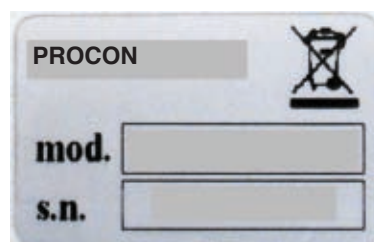

It's important to communicate this data in the event of a request for information or information concerning the instrument together with the program number and version that are shown on the cover of the manual and are displayed when the instrument is switched on.



### WARNINGS

The following procedures must be performed by qualified personnel.  
All connections must be performed when the instrument is switched off.

## TECHNICAL FEATURES

Power supply	24 Vdc $\pm$ 15 %
Max. absorption	5W
Insulation	Class II
Installation category	Cat. II
Operating temperature	-10°C ÷ +40°C (max. humidity 85% non-condensing)
Storage temperature	-20°C ÷ +50°C
Weight display	Numerical 6 red led digits and 7 segments (h 14 mm)
Led	4 LEDs of 3 mm
Keyboard	4 mechanical keys
Overall dimensions	106 mm x 58 mm x 90 mm (l x h x w)
Installation	Brackets for DIN profile section or OMEGA bar
Case material	self-extinguishing Noryl (UL 94 V1)
Connections	Screw terminal boards, pitch 5.08 mm
Load cells power supply	5 Vdc/120mA (max 8 cells of 350W in parallel), short-circuit protected
Input sensitivity	0.02 mV min.
Linearity	0.01% of the full scale
Temperature drift	0.001% of the full scale / °C
Internal resolution	24 bits
Resolution of the weight displayed	Up to 60,000 divisions on the net capacity
Measurement range	-0.5 mV/V to +3.5 mV/V
Frequency of weight capture	5 Hz - 50 Hz
Digital filter	To be selected from 0.2 Hz to 25 Hz
Number of weight decimals	0 ÷ 3 decimal places
Zero calibration and full scale	Automatic (theoretical) or executable from the keyboard.
Logic outputs	2 opto-isolated (dry contact), max 24Vdc / 60 mA each
Logic inputs	2 opto-isolated at 24 Vdc PNP (external power supply)
Serial port (# 2)	RS232C and USB (in parallel)
Maximum cable length	15m (RS232) and 1000m (RS422 and RS485)
Serial protocols	ASCII, Modbus RTU
Baud rate	2400, 9600, 19200, 38400, 115200 to be selected
Program code memory	64 Kbytes FLASH on-board reprogrammable from RS232
Data memory	2 Kbytes
Analog output (optional)	Voltage or current
Resolution	16 bits
Calibration	Digital from the keyboard
Impedance	Voltage: min. 10K $\Omega$ ; Current: max 300 $\Omega$
Linearity	0.03 % of the full scale
Temperature drift	0.001% of the full scale / °C
Fieldbus (optional)	PROFIBUS DP, DEVICENET, CANOPEN, PROFINET, ETHERNET, ETHERNET IP
Buffer dimension	128 byte IN - 128 byte OUT
Compliance with the standards	EN61000-6-2, EN61000-6-3 for EMC EN61010-1 for Electrical Safety UL: FILE NO E474362



# INSTALLATION

## GENERAL DATA

The DAT 400 is composed of a motherboard, on which you can add the options available; the motherboard is housed in a plastic enclosure by a 35mm DIN rail.



The DAT 400 should not be immersed in water, subjected to jets of water and cleaned or washed with solvents.

Do not expose to heat or direct sunlight.

## OVERALL DIMENSIONS

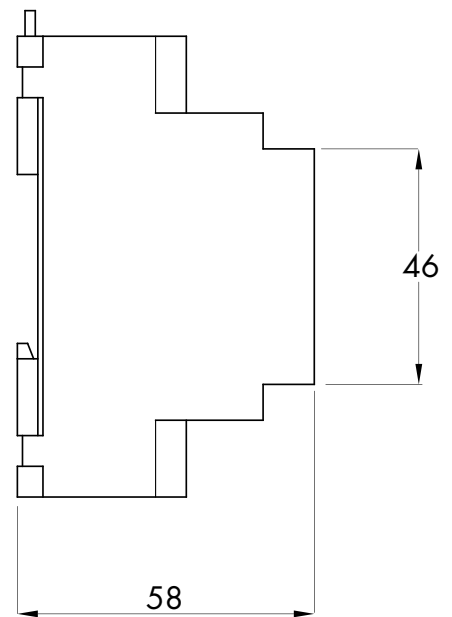
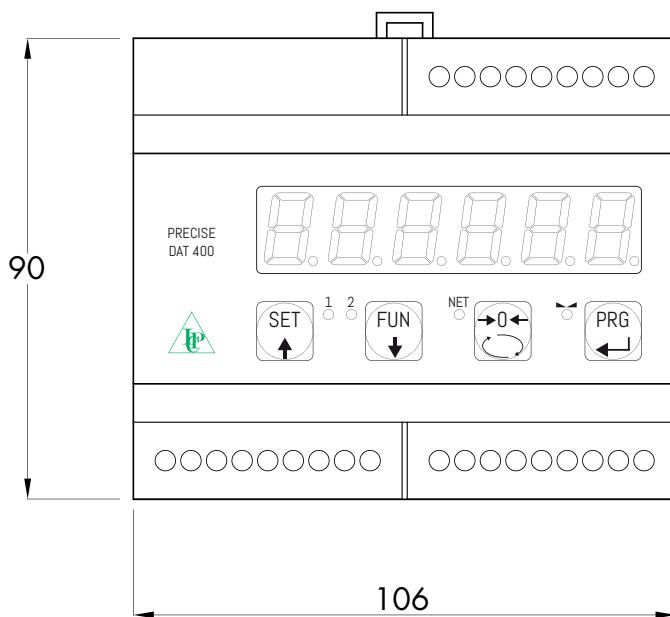

## ELECTRIC INSTALLATION



The transmitter DAT 400 uses screw terminal boards, pitch 5.08 mm, for the electrical connection. The load cell cable must be shielded and channeled away from tension cables to prevent electromagnetic interference.

## INSTRUMENT POWER SUPPLY

The instrument is powered through the terminals 8 and 9. The power cord must be channeled separately from other cables.

The supply voltage is electrically isolated.

Power supply voltage: 24 Vdc/  $\pm 15\%$  max. 5W

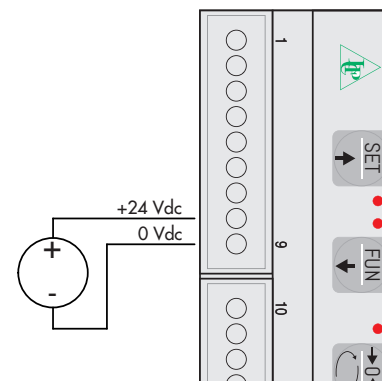

## CONNECTIONS OF THE LOAD CELL/S

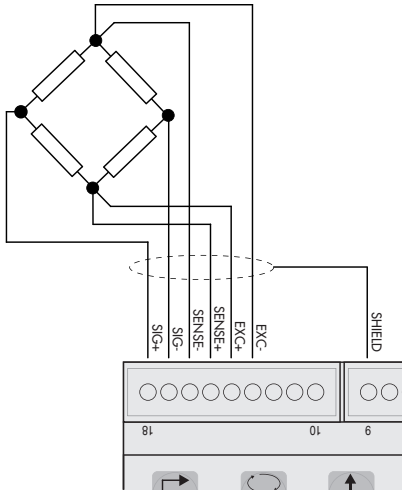

The cell/s cable must not be channeled with other cables, but must follow its own path.

The instrument can be connected up to a maximum of 8 load cells of 350 ohm in parallel. The supply voltage of the cells is 5 Vdc and is protected by temporary short circuit.

The measuring range of the instrument involves the use of load cells with a sensitivity of up to 3.5 mV / V.

The cable of the load cells must be connected to terminals 13-18. In the case of 4-wire load cell cable, jumper the terminals 13 to 16 and 14 to 15.

Connect the cell cable shield to the terminal 9.

In the case of the usage of two or more load cells, use special junction boxes (CEM4/C or CSG4/C). Below please find their connection.

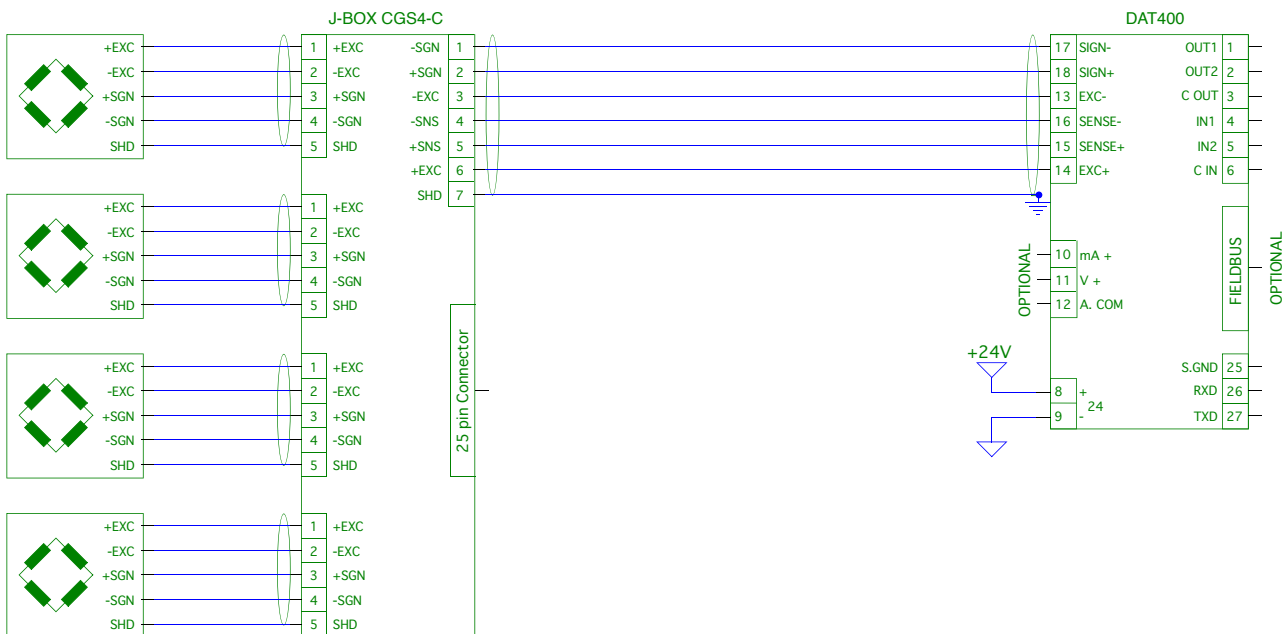

## LOGIC INPUTS

The two logic inputs are opto-isolated.

The cable connecting the logic input should not be channeled with the power cables.

The function of the two inputs is as follows:

INPUT1 Resetting the displayed value (gross, net or peak)

INPUT2 PRINT

The activation of the two functions is accomplished by bringing the external power supply 24 Vdc to the corresponding terminals as shown in the figure.

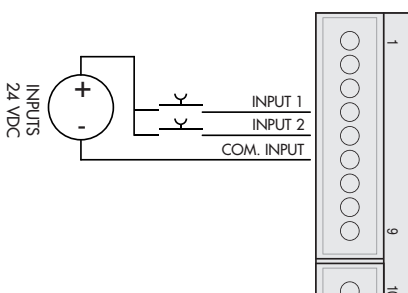



## LOGIC OUTPUTS

The two opto-isolated relay outputs are the normally open contact. The capacity of each contact is 24 Vdc, 100 mA max.

The cable connecting the outputs should not be channeled with the power cables. The connection should be as short as possible.

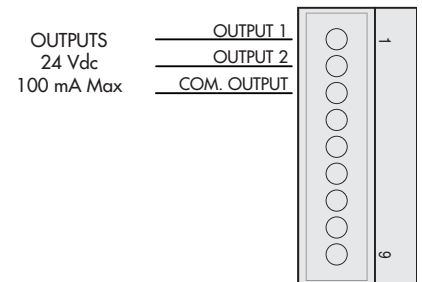

## SERIAL COMMUNICATION

### RS232:

The RS232 serial port is always present and handles various protocols.

To achieve the serial connection, use a shielded cable, making sure to connect the shield to one of the two ends: to pin 25 if connected on the side of the instrument, to the ground if it is connected on the other side.

The cable must not be channeled with power cables; the maximum length is 15 meters (EIA RS-232-C), beyond which you should take the optional RS485 interface.

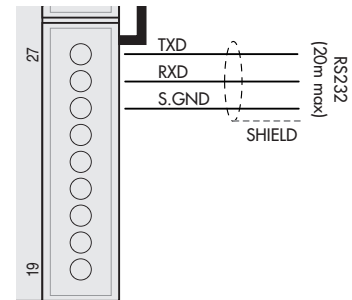

### RS485:

The serial port RS485 (2-wire) is present in the model DAT 400/RS485.

To achieve the serial connection, use a suitable shielded cable, making sure to connect the shield to one of the two ends: to pin 23 if connected on the side of the instrument, to the ground if it is connected on the opposite side.

The cable should not be channeled with the power cables.

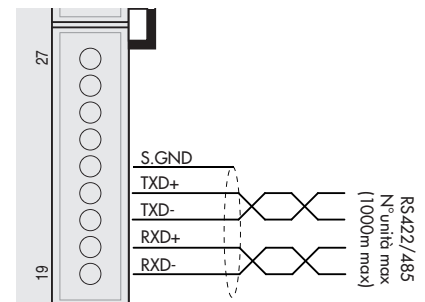

## ANALOG OUTPUT (OPTIONAL)

The transmitter provides an analog output in current and voltage.

Analog voltage output: range from -10 to 10 V or -5 to 5 V, 10 K $\Omega$  minimum load.

Analog current output: range from 0 to 20 mA or 4 to 20 mA. The maximum load is 300  $\Omega$ .

To achieve the serial connection, use a suitable shielded cable, making sure to connect the shield to one of the two ends: to pin 9 if connected on the side of the instrument, to the ground if it is connected on the opposite side.

Attention: do not connect the analog output to devices that are switched on.

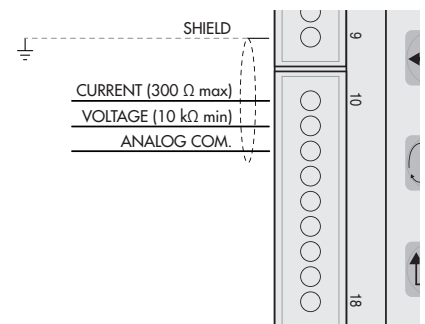

## PROFIBUS DP CONNECTION (OPTIONAL)

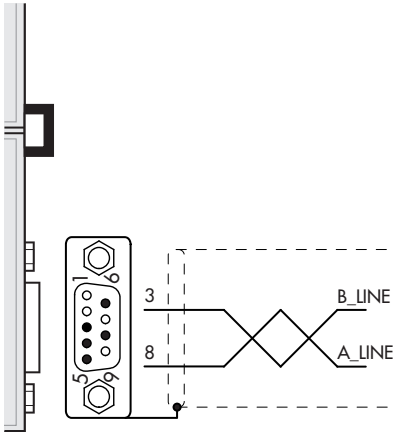

Pin	Signal	Description
1	-	-
2	-	-
3	B line	+RxD/+TxD, level RS485
4	RTS	Request to send
5	GND	Ground (isolated)
6	+ 5V Bus Output	+5V termination (isolated)
7	-	-
8	A line	-RxD/-TxD, level RS485
9	-	-
Housing	Cable shield	Internally connected to protective earth according to Profibus specification

For connection to the Profibus Master, use a standard Profibus cable.

The typical impedance of the cable should be between 100 and 130 Ohms ( $f > 100$  kHz). The cable capacity (measured between conductor and conductor) should be less than 60 pF / m and the minimum cable cross section should not be less than 0.22 mm<sup>2</sup>

In a Profibus-DP network, you can use either cable type A to type B cable, depending on the required performance. The following table summarizes the features of the cable to be used:

Specification	Type A Cable	Type B Cable
Impedance	from 135 to 165 ohm ( $f = 3 - 20$ MHz)	from 100 to 300 ohm ( $f > 100$ kHz)
Capacity	< 30 pF/m	< 60 pF/m
Resistance	< 110 ohm/km	-
Conductor cross section	> 0,34 mm <sup>2</sup>	> 0,22 mm <sup>2</sup>

The following table shows the maximum length of the wires line with cable type A and type B, function of the different communication speed required:

Baud rate (kbit/s)	9.6	19.2	187.5	500	1500	3000	6000	12000
Cable A length (m)	1200	1200	1000	400	200	100	100	100
Cable B length (m)	1200	1200	600	200	-	-	-	-

For a reliable operation of the Fieldbus, should be used a line termination at both ends.

In the case of multiple DAT 400 instruments, use the line termination at only one instrument.

For configuring the instrument, the GSD file is available (hms\_1810.GSD) that must be installed in the master.

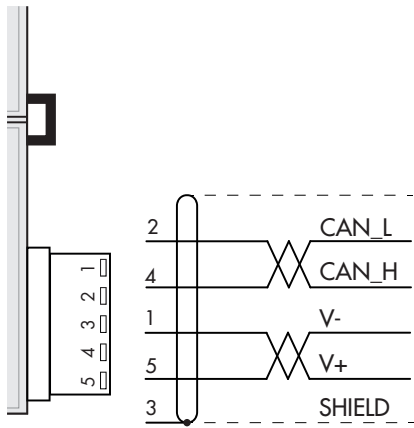

### DEVICENET CONNECTION (OPTIONAL)

Pin	Signal	Description
25	V-	Negative power bus
26	CAN_L	CAN low bus line
27	SHIELD	Schermo del cavo
28	CAN_H	CAN high bus line
29	V+	Positive power bus

To connect to the DeviceNet master, use a standard DeviceNet cable or shielded twisted-pair cable as shown on the diagram.

The cable must not be channeled with power cables. For reliable operation of the Fieldbus, should be used as a line termination of 121  $\Omega$  value between the terminal CAN\_L and CAN\_H.

For the configuration of the card is available ESD file that must be installed in the master.

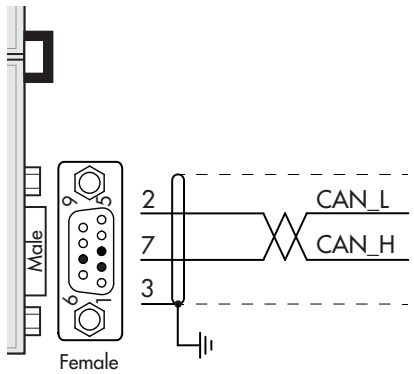

### CANOPEN CONNECTION (OPTIONAL)

Pin	Signal	Description
2	CAN_L	CAN low bus line
3	CAN_GND	
7	CAN_H	CAN high bus line

CANopen is an higher-layer communication protocols based on a CAN serial bus system.

For the connection using a cable with a twisted pair differential and common return in accordance with ISO 11898. The length of the bus is limited by the speed of communication chosen according to the following table:

Bit Rate	Max. Bus length
1 Mbit/sec	25 m
500 Kbit/sec	100 m
250 Kbit/sec	250 m
125 Kbit/sec	500 m
$\leq 50$ Kbit/sec	1000 m

Despite the theoretical maximum number of nodes in a CAN network is 127, the maximum number supported by the DAT 400 is 64.

The CAN line must have the resistance of 120 $\Omega$  termination.

The reference CAN\_GND must be connected to earth at one point of the line.

The cable can not be channeled with power cables.

For the configuration of the card is available ESD file that must be installed in the master.

## ETHERNET CONNECTION (OPTIONAL)

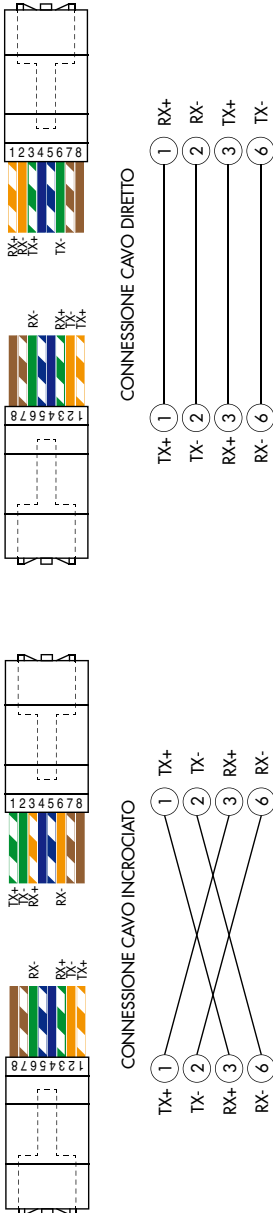

Pin	Description
1	TX+
2	TX-
3	RX+
4	
5	
6	RX-
7	
8	

### Specifications:

Ethernet protocols: TCP, Modbus/TCP, UDP, IP, ICMP, ARP

Speed: 10 Mbps

You can connect the interface to the PC directly without going through other network devices (routers, switches, hubs, LAN-bridge or whatever), but it must be used RJ45 special cables, called "crossover"

Normally the cables are "direct" and allow the connection to network devices such as routers or hubs, but they don't allow the direct connection of two PCs (although currently there are network cards with auto-sensing technology, which recognize the type of cable and the type of connection, allowing direct connections to PC-PC also using crossover cables).

On the left are the diagrams of the two types of cables and related wiring diagram.

The cable must not be channeled to other cables (eg outputs connected to contactors or power cables) but, if possible, should follow their own path.

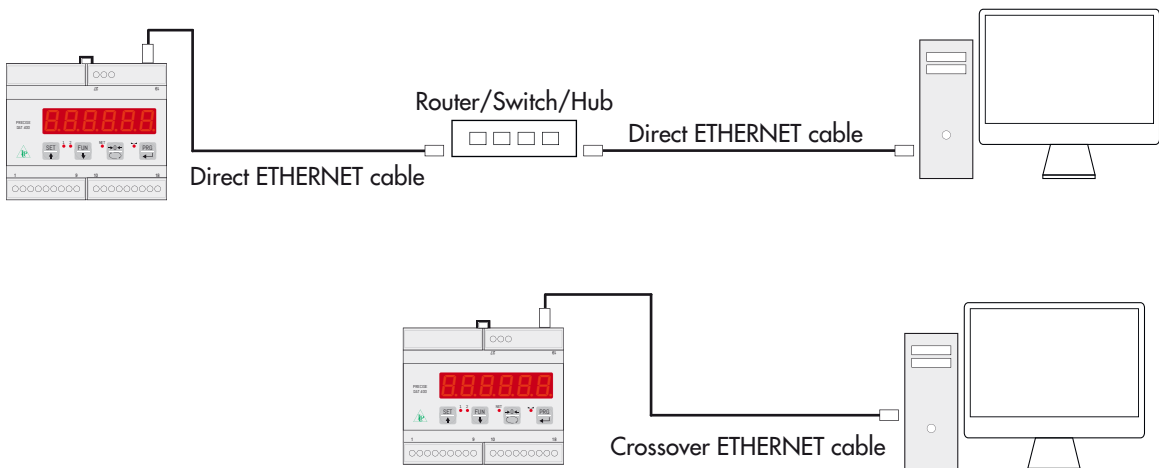

## FRONT PANEL OF THE INSTRUMENT

The DAT 400 has a bright 6-digit display, 4 status LEDs and four keys.

In this operating mode the display shows the weight and the LEDs indicate the status of weight and the setpoints.

The set-up parameters are easily accessed and modified through the use of the three front buttons used to select, edit, confirm and save the new settings.



### DISPLAY

On the 6-digit display, it's usually shown the scale weight. According to the various programming procedures, the display is used for programming of the parameters to be stored in the memory, or the messages that indicate the type of operation being carried out and help therefore the Operator in the management and programming of the instrument.

### LED INDICATORS

Below the display there are 4 LED indicators:

1 State of the logic output 1 (ON = closed contact OFF = open contact)









2 State of the logic output 2 (ON = closed contact OFF = open contact)





NET The displayed value is the net weight





0 IT indicates the condition of stable weight.



## USING THE KEYBOARD

The instrument is programmed and controlled through the keyboard which has 4 keys, with double functions. The selection of one of the key functions is established automatically by the instrument according to the operation in progress. In general, the management of the programming menus is done by using the SET and FUN keys to scroll through the items; the PRG key is used to enter its sub-menu or programmable parameter, while the 0 button allows you exiting the menu or returning to the top level.

KEY	FUNCTIONS DURING THE WEIGHT DISPLAY
	Access to the menu for the programming of the setpoints
	Select the display view (gross weight, net weight). (Long press) Selection of the weight/peak display
	Resetting the displayed value (gross weight, net weight or peak). (Press and hold for 5 sec.) Calibration of zero, to be executed only if its function is enabled in the PARAM menu (see item "0 ALL").
	Sending the weight string on the serial line. (Long press) Access to the quick set-up menu.
 + 	(Press for 3 sec) Access to the setup menu.
 + 	(Press for 3 sec) It accesses the keypad lock/unlock menu and auto-off function of the display.

KEY	FUNCTION DURING THE MAIN MENU DISPLAY
	It selects the next parameter.
	It selects the previous parameter.
	It exits the programming menu or returns to the upper level.
	It accesses the corresponding sub-menu or programming or confirms the selected parameter.

KEY	FUNCTION WHEN SETTING THE NUMERICAL VALUES
	It increases the value of the flashing digit.
	It decreases the value of the flashing digit.
	It goes to the next digit.
	It confirms the displayed value.

KEY	FUNCTION WHEN SETTING THE NUMERICAL VALUES
	It selects the next value.
	It selects the previous value.
	It confirms and store the displayed value.

### EXIT FROM THE SETTING MENU

Press the  key to return to the main menu. Press the  key again. It's displayed "SE0REP".

Press the  key to return to the main menu.

To exit without saving any changes, switch off the instrument instead of pressing the  key.

## INFO DISPLAY

When the instrument is switched ON, you can test the display, then in sequence you can display the identification code of the software and its version. Communication codes in the event of a request for assistance.

### ERRORS NOTIFICATION

In the operation mode, the display can report the following error codes.

- the weight applied to the load cell exceeds by more than 9 divisions the maximum capacity of the weighing system.
- 0-L* Signal of the load cells absent or outside of the measurement range mV/V.
- no Lon* Fieldbus network disconnected
- E-PrOF* PROFIBUS or PROFINET interface absent or not operating.
- E-dnEt* DEVICENET interface absent or not operating.
- E-LAnP* CANOPEN interface absent or not operating.
- E-EtH* ETHERNET interface absent or not operating.
- Dash that runs along the perimeter of the display: BLIND function enabled.
- ErrnEn* Memory error. Press the PRG key to reset the memory and return the parameters to their default values. NOTE: it is also deleted the calibration performed.



## VIEWING, ZEROING THE WEIGHT AND AUTOTARE

After being calibrated, at the subsequent switches on, the display shows the current weight.

### VIEWING THE NET WEIGHT/GROSS WEIGHT



Press the  key to toggle between the net weight and the gross weight and vice versa. The value displayed is signaled by the LED NET (lit: net weight). If you have not entered the tare, the net weight is equal to the gross weight.

In case of negative weight, it is displayed the minus sign before the most significant digit.

### ZEROING, WEIGHT AND AUTOTARE

These two functions are performed by pressing 0.

When the instrument is in the operation mode "Net" ("NET" LED on), the 0 key performs the AUTOTARE.

When the instrument is in operation mode "Gross" ("NET" LED off), the 0 key clears the gross weight.

### AUTOTARE

The execution of AUTOTARE is possible under the following conditions:

- Instrument under conditions of "Net" (NET" LED on).
- Positive gross weight.
- Gross weight not greater than the maximum capacity.
- Stable weight.
- Unstable weight. In this condition, we must distinguish two cases:
  1. The weight stability control is enabled (the parameter "MOTION" (\*) must be other than zero): the command executed while the weight is unstable only has an effect if the weight stabilizes within 3 seconds from the moment the command was given.
  2. The weight stability control is disabled (the parameter "MOTION" (\*) is equal to zero): the executed command takes effect immediately, even with unstable weight.

(\*) *The operating modes of the parameter "MOTION" are described on page 28.*

The AUTOTARE is retained in memory even after the power is switched off.

### ZEROING

The reset command of the gross weight is used to correct for small zero shifts of the weighing system during normal operation.

Normally these zero shifts are due to thermal drifts or to residues of material that accumulate on the weighing system over the time.

To run the command, it is necessary that the instrument is under conditions of "Gross" ("NET" LED off) and that the deviation of the weight with respect to the zero of the scale (the one performed with the calibration of zero) does not exceed (in positive or negative) the number of divisions set in parameter "O BAND" (inside the PARAM menu).

The reset command of the gross weight does not run if there is even one of the following conditions:

- Unstable weight (with control of the stability of the weight enabled). In this case, the reset command takes effect only if the weight stabilizes within 3 seconds or if the control of the weight stability is disabled (parameter "MOTION " equal to zero).

- Gross Weight greater (in positive or negative) than the number of divisions set in parameter "0 BAND" , when the setpoint of auto-calibration is not programmed.

The zero obtained with the resetting of the gross weight is retained in memory even after the power is switched off.

The reset operation of the gross weight can be repeated several times, but the number of reset divisions zero is added from time to time, so when the total exceeds the limit value set in parameter "0 BAND" , the zero cannot be executed. In this case, it is necessary to calibrate the Zero.

Any auto-zero parameter setting when switching on (AUTO 0) reduces (or cancels, in the case of "AUTO 0"> "0 BAND") the range of action of the reset command.

### PEAK FUNCTION

The instrument continuously memorizes the peak value of the gross weight. The peak value is detected at the same frequency of acquisition of the weight (see table on filters). In addition to visualization, the peak value can be used in the following functions:

FUNCTION	DESCRIPTION
LOGIC OUTPUT	The setpoints can be set to have the peak value as a reference. (See the procedure for setting the logic outputs operations).
SERIAL PORT	Acquisition of the peak value (peak hold) through the CONTIN, AUTO, DEMAND, SLAVE and MODBUS protocols.
ANALOG OUTPUT	The analog output value can assume the value of the peak (peak old). (See the procedure for setting the analog output).

Press the "FUN" key and hold it for 3 seconds until the left of the display shows the letter "P".

### INPUT / OUTPUT FUNCTIONS

INPUT	
1	Resetting the displayed value (gross weight, net weight or peak). Closed for 5 sec. -> Calibration of zero, to be executed only if its function is enabled in the PARAM menu (see item "0 ALL").
2	Sending the weight string on the serial line or print.
OUTPUT	
1	Setpoint 1
2	Setpoint 2

## PROGRAMMING THE WEIGHT SETPOINTS

The set setpoint values are compared with the weight to drive its logic output. The comparison criterion is established in the process of set-up of the logic I / O (see relevant paragraph).

To access the Setpoint setting, press the SET key and follow the instructions on the table below.

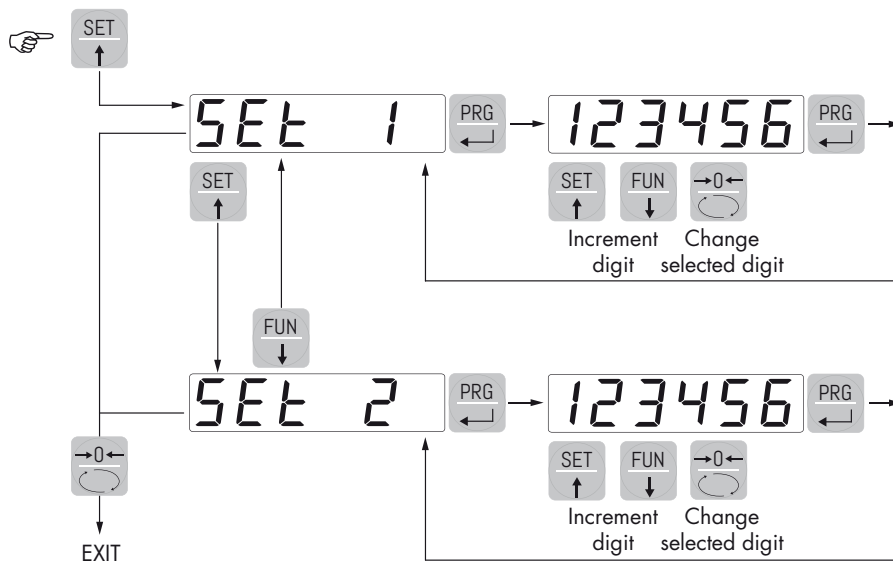

During the step of setting the setpoints, both outputs are disabled. If the setpoint value in memory is 0, the corresponding output is never enabled, regardless of the set-up of the selected setpoints. When the weight is not detectable or out of range, all outputs are disabled (contact open or closed depending on the MODE; see the relevant chapter).

## KEYBOARD LOCK/UNLOCK FUNCTION

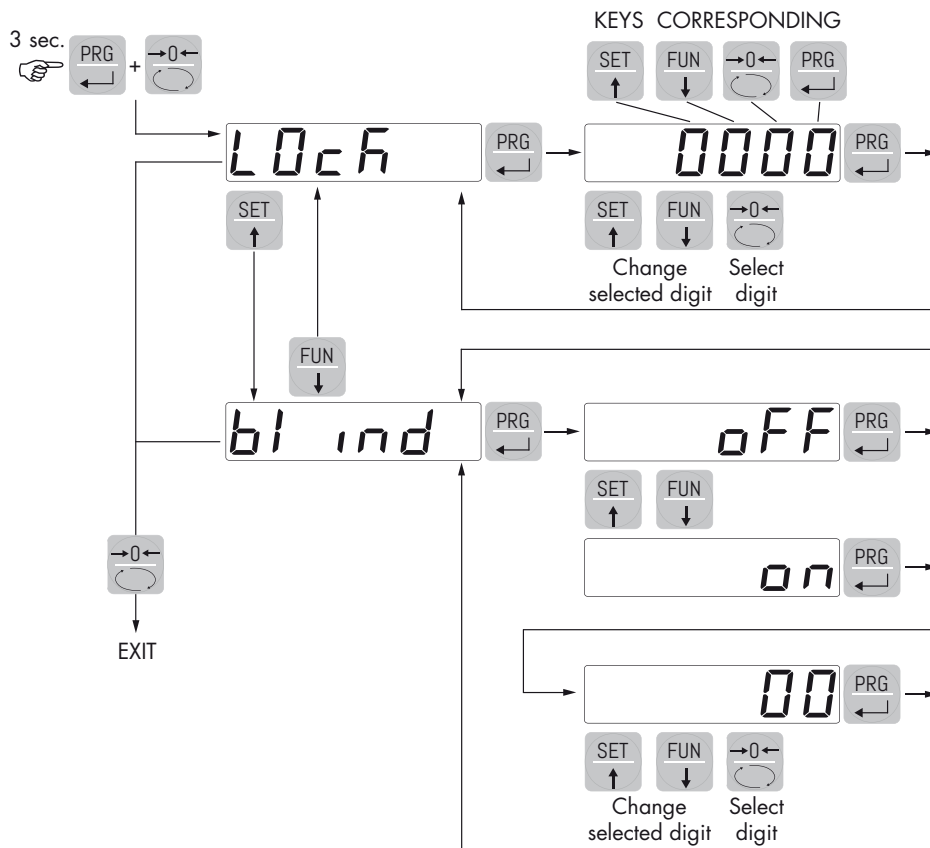

**KEYBOARD LOCK/UNLOCK** A function that allows you to enable or disable the keys individually. When the keys are locked, the only way to access these settings is to press and hold pressed the PRG + 0 keys for 3 seconds. For more information on the function, refer to the block diagram above.

**SWITCHING THE DISPLAY OFF** This function allows turning off the display after a programmable time. You can select ON / OFF of the parameter BLIND and the setting of a time; the time count starts from the moment when, after exiting the setup menu, the display shows the weight value. After the set time, the display turns off and only a dash appears. This dash cycles through the perimeter of the display counterclockwise. When the display is off, also the 4 keys are disabled, regardless of how you set the keypad lock (LOCK). The only way to access the settings will be PRG + 0.

# SETTING

## GENERAL DATA

All functions of the DAT 400 are activated and modified by accessing a simple setup menu, shown on page 21. All settings selected or activated remain stored even after switching off the transmitter.

The DAT 400 is preconfigured with a default setting. The following pages show the values of "Default" for each parameter.

With the first on-site installation, it's necessary to change some parameters in order to obtain a correct indication of the displayed weight (Theoretical adjustment).

This may be required when you purchase the DAT 400.

The settings of the setup menu can be changed using the front keys or via the utility "INOVATION 2" software supplied.

## CHANGING AND ENTERING THE PARAMETERS:





The setup parameters are grouped into a number of main menus.





To access the setup menu press the PRG key and then the SET key and hold down simultaneously for 3 seconds.



The display shows the message *CONF IG* that is the first of the main menus.

Use the arrow keys to select the menu you want to change.



Press the PRG key to access the selected menu.

KEY	FUNCTION DURING THE MAIN MENU PROGRAMMING
	It selects the next menu.
	It selects the previous menu.
	It exits the programming menu or returns to the upper level.
	It accesses the corresponding sub-menu or programming or confirms the selected parameter.

KEY	FUNCTION WHEN SETTING THE NUMERICAL VALUES
	It increases the value of the flashing digit.
	It decreases the value of the flashing digit.
	It goes to the next digit.
	It confirms and store the displayed value.

KEY	FUNCTION WHEN SETTING THE PROSED VALUES
	It selects the next value.
	It selects the previous value.
	It confirms and store the displayed value.

The menu parameters can assume values that can be set or selected.

NOTE To exit and save the modified data, press multiple times the  key until the display shown *StorE*, then press  key to go back to the operating mode.

# DIAGRAM OF THE MENU

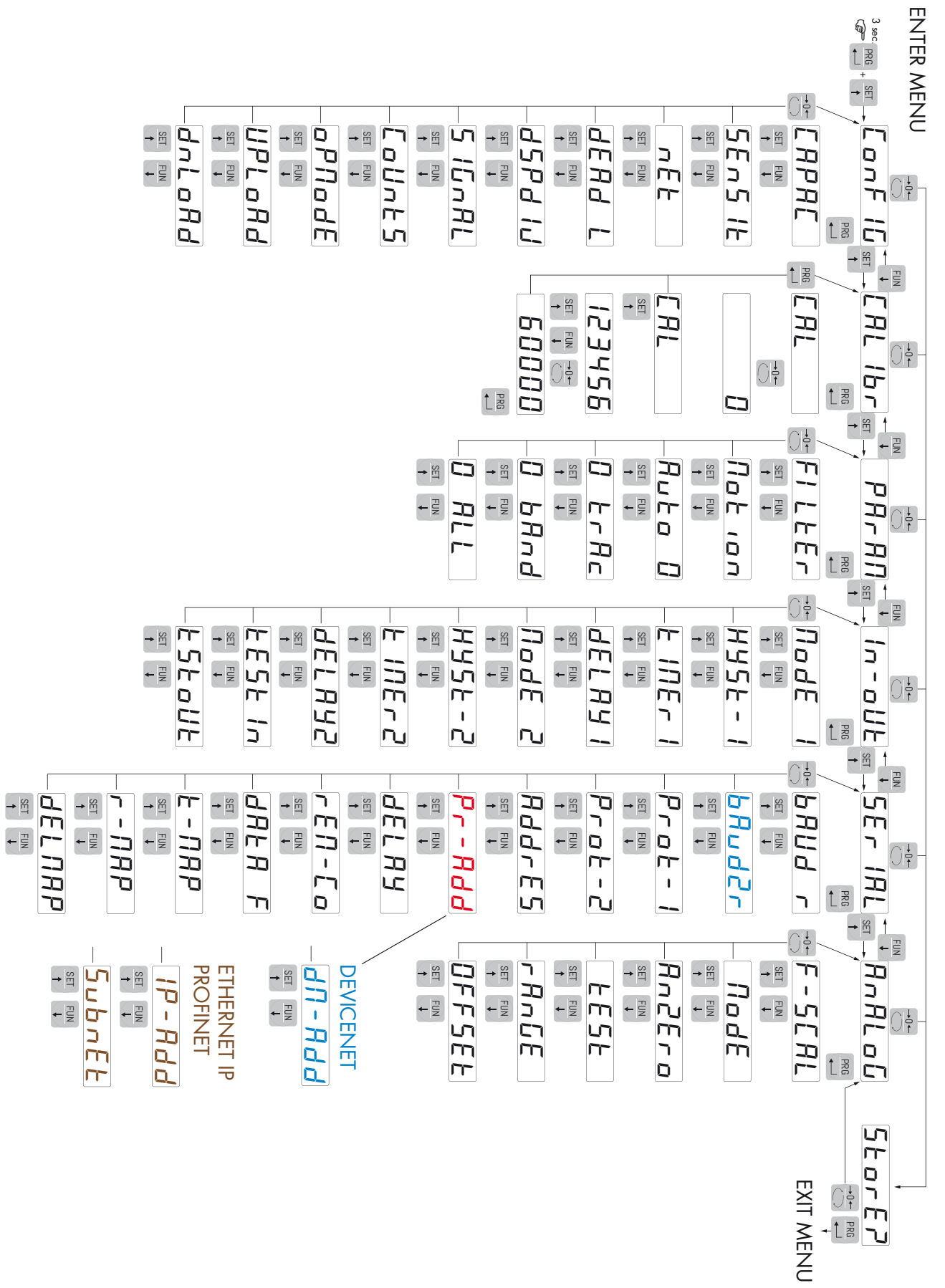

# QUICK SETUP MENU

## ENTER MENU

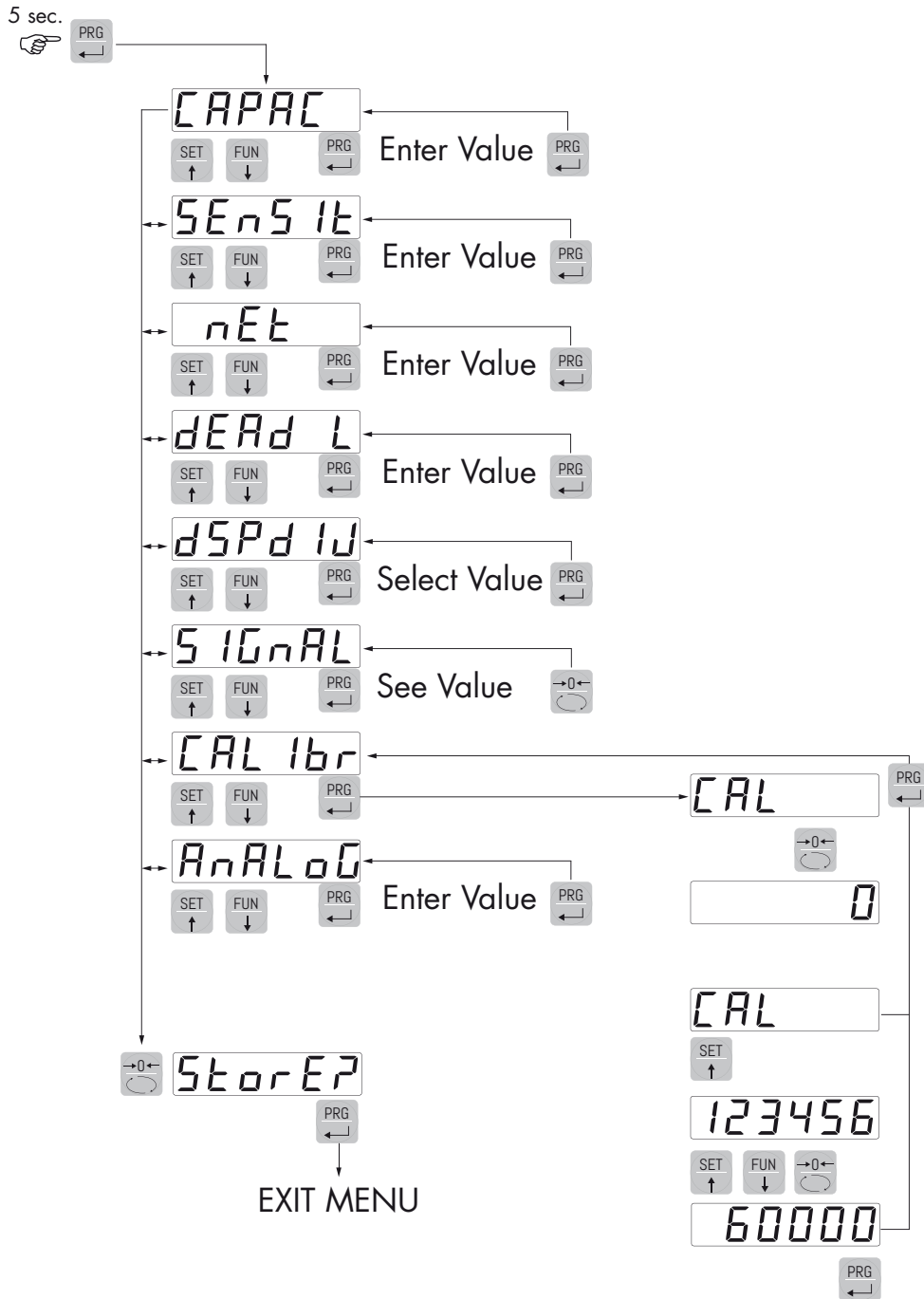



# CONFIGURATION PARAMETERS

Through the setting of the parameters listed below, the theoretical Full Scale DAT 400 calibration is performed. These steps with the zero calibration described on the next page must be completed. The procedure ensures a good accuracy of the system (maximum error <1% FS) if there are no mechanical problems.

Program the known values of total capacity and sensitivity of the load cells and the approximate values of net capacity and calibration. If the parameter SENSIT is not programmed, it is taken the 2.0000 mV/V value.

If the parameter CAPAC is programmed other than 0, according to the data CAPAC, SENSIT, NET and DEAD L, the instrument automatically runs the following functions:

Resetting the linearization points.

Selection of the value of the division, however, to be modified, to the best of 10,000 divisions.

Calibration of the theoretical approximate calibration of the weight (zero and full scale).

Automatic programming of the overload setpoint (= NET).

These functions are performed each time you change one of the 4 parameters shown.

When you change the DSPDIV selection., it is automatically recalculated to full-scale calibration. The selections are incompatible with the calibration parameters or calibration in memory are not accepted.

The selection programmed in Opmode is read from the instrument when it is switched on and it makes that the instrument operates in that way.

## CAPAC CAPACITY OF THE WEIGHING SYSTEM

It defines the value corresponding to the sum of the rated capacity of the load cells. In the case of systems with only one load cell and "N" fixed supports, enter the capacity value of the cell for the total number of supports. This figure represents the full scale value of the weighing system.

Following the change of the parameter value, the theoretical tare of the weight is recalculated.

Values: from 1 to 500000

Unit: the same of that displayed

Default: 10000

## SENSIT LOAD CELLS SENSITIVITY

Set the value corresponding to the average sensitivity of the load cells, in mV / V. The instrument accepts values between 0.5 and 4 mV / V. If no value is programmed, it's assumed it is 2mV/V.

Following the change of the sensitivity value, the theoretical tare of the weight is recalculated.

Values: from 0.5000 to 4.0000 mV/V

Default: 2.0000

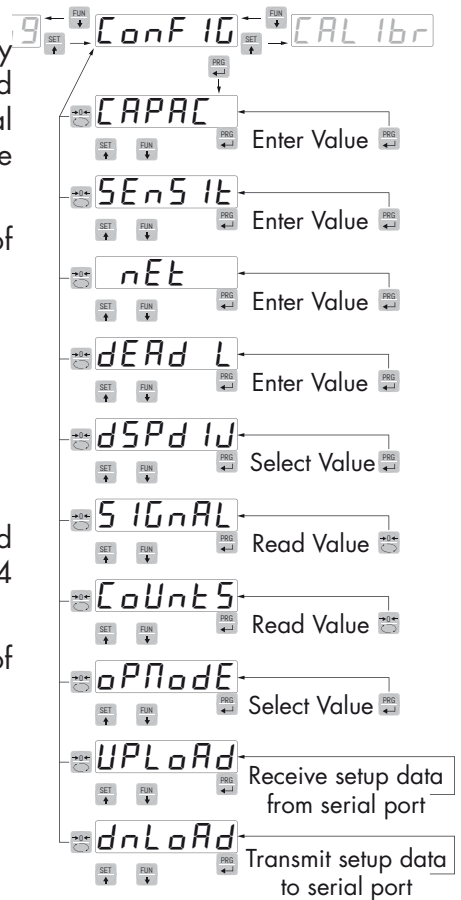

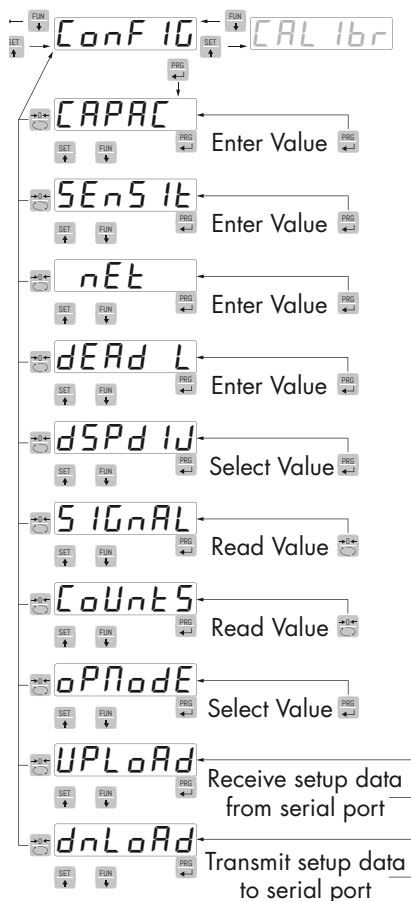

### **NET CAPACITY OF THE WEIGHING SYSTEM**

Programming the net capacity of the weighing system. Values lower than 1/10 of *CAPAC* are not accepted.

*Values: from 1 to 500000*

*Unit: the same of that displayed*

*Default: 10000*

### **dEAd L FIXED CALIBRATION OF THE WEIGHING SYSTEM**

Programming the fixed calibration value of the weighing system.

*Values: from 1 to 500000*

*Unit: the same of that displayed*

*Default: 00000*

### **dSPd IJ DIVISION VALUE**

The ratio between the capacity of the system and the division value represents the resolution of the system (number of divisions).

Following the change of the capacity of the system, it is automatically selected the division value to the best of 10000 divisions.

Following the change of the division value, if the maximum capacity does not change, the calibration of the weight is automatically corrected.

*Value to be selected:*

*0.0001 - 0.0002 - 0.0005*

*0,001 - 0,002 - 0,005*

*0.01 - 0.02 - 0.05*

*0.1 - 0.2 - 0.5*

*1 - 2 - 5*

*10 - 20 - 50*

*Default: 1*

### **S IGrAL TESTING THE LOAD CELLS SIGNAL**

It's displayed the signal acquired from the load cells expressed in mV/V.

### **CoUntS A/D CONVERTER INTERIOR POINTS TEST**

View of the interior points of the instrument (1,000,000 at the maximum input signal).

### **oPNode SELECTION OF THE OPERATING MODE**

Selection of the operating mode of the device (display) when it is switched on:

*Value to be selected:*

*GROSS, NET, PEAK*

*Default: GROSS*

## UPLoAd RECEIVING DATA FUNCTION

Receiving function from a serial of a file containing the setup data that will be automatically set in the instrument.

## dnLoAd SENDING DATA FUNCTION

Sending function from a serial of a file with the content of the setup memory of the instrument.

## EXAMPLE OF SETTING/CALIBRATION

To weigh a tank, with empty weight of 750 kg and with a capacity of 1000 liters, containing a product with a specific gravity of 1.33 to read the weight with a display resolution of 0.2 Kg.

Before proceeding with the configuration, make sure that the load cells are connected properly to the unit and the tank is empty and set the parameters.

They are used:

Nr 3 load cells with capacity of 1000 kg

Sensitivity of respectively 2.0015, 2.0008 and 1.9998 mV/V (average value = 2.0007 mV/V)

Set the following values in the configuration parameters:

**CAPAC = 3000**

**SEnS it 2.0007**

**nEt 1500**

**dERd L 0**

**dSPd lD 0.2**

Make sure that the value read in the *SiGnAL* parameter corresponds with the calibration weight of the system according to the following proportion:

$$3000:2.0007=750:X$$

Where X is the value of the signal expressed in mV/V corresponding to the theoretical value of the weight of the empty tank. The value should be about 0.5 mV/V.

Proceed to the calibration described in the following paragraph, or you can exit the configuration menu by saving the data entered.

The instrument should indicate the value corresponding to the weight of the empty tank (for example 756.8).

Re-access the configuration menu and enter the weight value read in the *dERd L* parameter and enter the value 756.8.

Quit the configuration menu by saving the data.

For greater accuracy, prepare some sample weights or the pre-weighed material on a certified system and calibrate as described in the next paragraph.

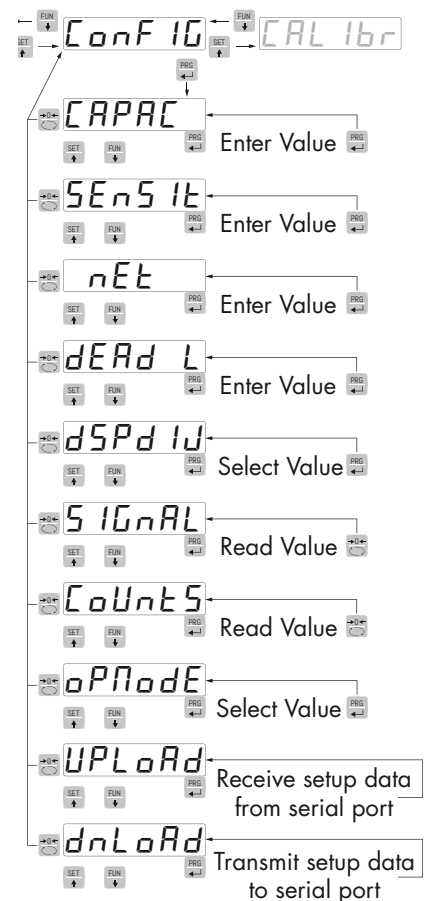

# CALIBRATION

The calibration described herein should be performed with the use of sample weights and/or product pre-weighed on a weighing system.

Before proceeding with the calibration of the full scale, always perform the zero calibration.

During the calibration phase, the display shows the weight intermittently with the inscription *CAL*.

**ATTENTION:** At switching off the instrument without exiting the set-up menu, the programming executed is not stored.

**NOTE** In the event that after calibration, the system shows linearity errors, you should verify that the weighed structure is completely free of mechanical constraints.

## ZERO CALIBRATION

Perform the operation when the scale has no items (including the fixed tare), and when the weight is stable. The zero of the system is done by pressing the key 0.

The weight displayed resets and the display shows *CAL* alternated by 0. You can repeat this operation more times.

## CALIBRATION OF FULL SCALE

Prior calibration load the sample weight on the system and wait for the stabilization; the display shows a weight value.

Press the SET key to adjust the weight. The display shows the theoretical weight value with the first digit to the left flashing. With the arrow keys, enter the actual weight loaded on the system starting from the first flashing digit. Switch to the next digit by pressing 0. The confirmation of the last digit (far right) with the PRG key corrects the weight. The display shows *CAL*, by altering the actual weight value entered.

If the set value is higher than the resolution offered by the instrument, the weight is not accepted and the display shows an error message for a few seconds.

This procedure can be repeated.

Press the PRG key again to return to the *CALIB* menu.

## EXIT FROM CALIBRATION MENU

The exit from the menu *CALIB* is performed by pressing the key until the appearance of the message *STOP?*



To store the new calibration and exit the setup menu, press the PRG key.

To cancel the calibration of zero and full scale:

FUN +0 it cancels the zero calibration.

FUN + SET it cancels the calibration of the full scale.

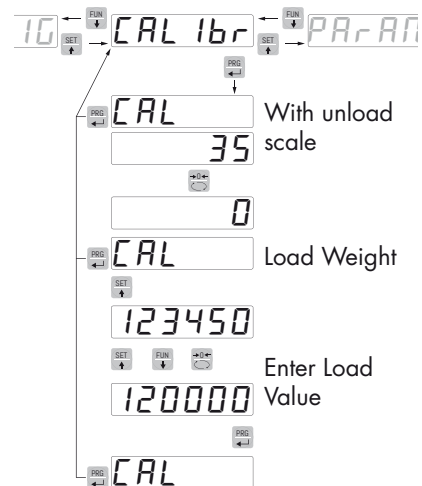

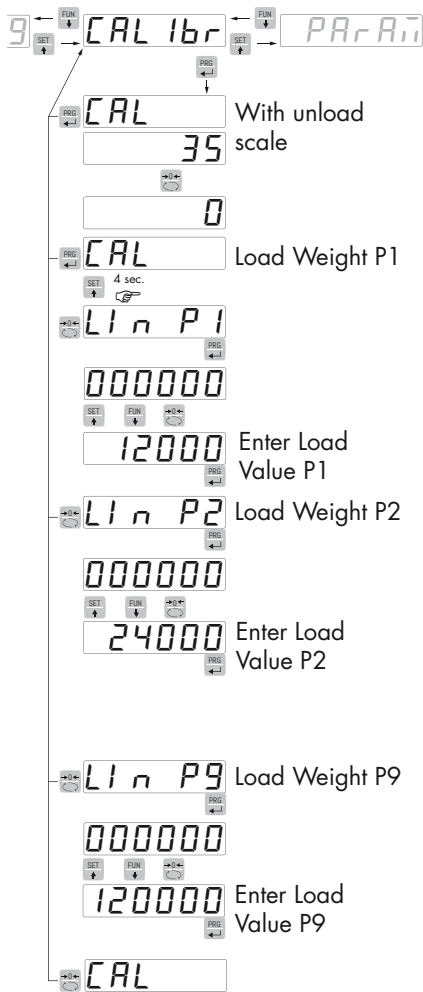

## LINEARIZATION PROCESS

When planning the sample weight, values greater than the full scale, or lower than the previous point, or when the weight is not stable, are not accepted. If the entered value is accepted, it is proposed the next step, otherwise still the same.

The linearization points are automatically reset by any change of the data of the theoretical calibration or it is performed a full-scale calibration.

# WEIGHING PARAMETERS

The parameters in this menu allow the adjustment of the acquisition and updating timing of the display and the manual or automatic zeroing performed by transmitter

## *F I L T E R* **WEIGHT FILTER**

This parameter adjusts the refresh speed of the display and the serial and analog output.

Low values of the filter speed up the display refresh.

High values of the filter slow down the display refresh.

Value	Update	Response
0	50 Hz	25 Hz
1	50 Hz	16 Hz
2	25 Hz	8 Hz
3	25 Hz	5 Hz
4	25 Hz	2.5 Hz
5	10 Hz	1.5 Hz
6	10 Hz	1 Hz
7	10 Hz	0.7 Hz
8	5 Hz	0.4 Hz
9	5 Hz	0.2 Hz

Default: 5

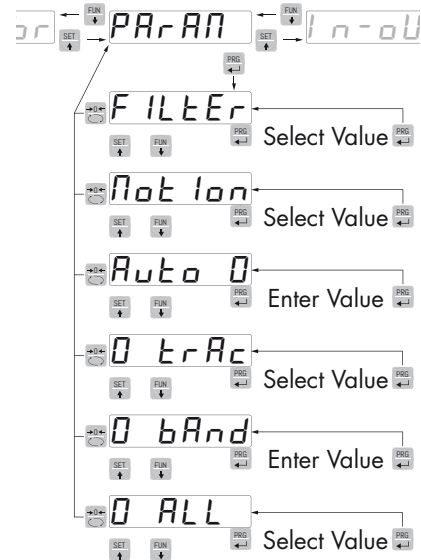

## *Not Ion* **WEIGHT STABILITY**

This parameter defines the divisions number needed to deem the weight stable.

A large number of divisions allows the transmitter to detect quickly the weight stability, which is needed when executing tare and print commands.

Value	Change
0	Always stable weight
1	Stability determined quickly
2	Stability determined with medium parameters
3	Stability determined accurately
4	Stability determined with the highest accuracy

Default: 2

## *Auto 0* **AUTOZERO UPON SWITCHING ON**

This parameter defines the value of the maximum resettable weight when the instrument is switched on.

This operation corresponds to a zero calibration of the system and is executed only if the weight is stable and below the set value.

Value from 0 to the value of the CAPAC parameter.

Default: 0



### 0 trAc **TRACKING THE ZERO**

This function allows you to perform a momentary zero calibration compensating for the temperature drift of the weight.

At switching off, it automatically returns to the previous zero calibration.

The maximum weight resettable by this parameter is 2% of the range of the system.

To disable this feature, use the value 0.

Value	Change
0	Control OFF
1	0.5 div/sec
2	1 div/sec
3	2 div/sec
4	3 div/sec

Default: 0

### 0 bAnd **ZERO BAND**

This parameter defines the number of divisions resettable by the pressure of the front button of zero or by Input 1.

Values: from 0 to 200

Default: 100

### 0 ALL **ZERO CAL**

Enables the function that allows to perform zero calibration by pressing and holding the 0 key or input 1 for 5 sec.

Value:

Off            Function disabled

On            Function Enabled

Default: Off

# INPUT/OUTPUT PARAMETERS

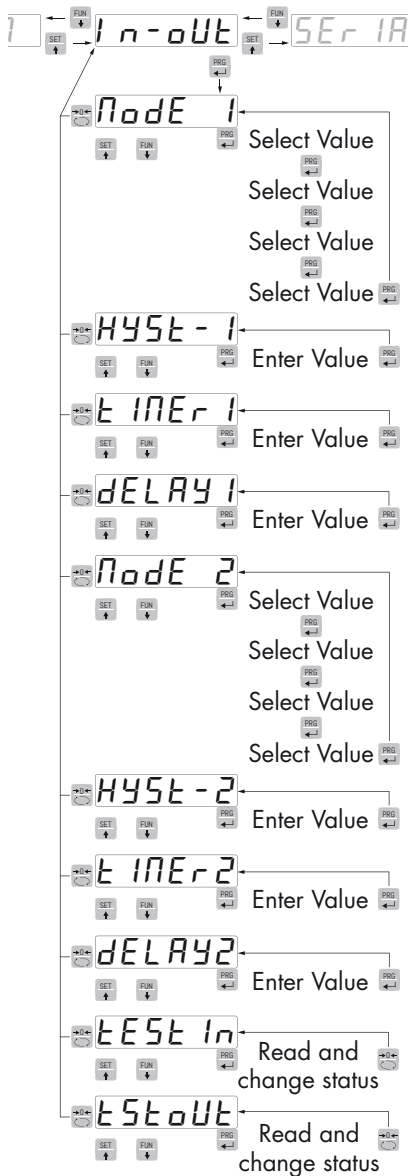

## Node 1 SETPOINT 1 OPERATION MODE

Select 4 operation criteria of the setpoint 1 in sequence:

- NET* The relay output is active in Net Weight mode
- GROSS* The relay output is active in Gross Weight mode
- PEAK* The relay output is active in Peak mode
- Default: GROSS*

Comparison with the net weight, gross weight or the peak. In this last case, the comparison is made with the last peak value acquired, even when the peak function is not active.

- N.O.* The relay 1 is normally open
- N.C.* The relay 1 is normally closed
- Default N.O.*

- POS.* The output is operating with positive weight
- NEG.* The output is operating with negative weight
- Default: POS*

- NORML* Output 1 is active with unstable weight
- STABL* The output is active with stable weight
- Default: Norml*

## HYSt-1 HYSTERESIS OF THE SETPOINT 1

Hysteresis value than the setpoint value set.

- Value: from 0 to 999*
- Default: 2*

## t INEr 1 SETPOINT 1 TEMPORIZAZION

Value of time, in tenths of a second, during which, when the weight value set is overcome, the output relative to setpoint 1 remains enabled.

After this time, even if the weight value is still above the setpoint, the output is automatically disabled.

The function is not activated if the programmed time is equal to zero.

- Value: from 0 to 999*
- Default: 0*

## dELAY 1 SETPOINT 1 DELAY

Value of time, in tenths of a second, after which, when the weight value set is overcome, the output relative to setpoint 1 remains enabled.

The function is not activated if the programmed time is equal to zero.

- Value: from 0 to 999*
- Default: 0*



## Node 2 SETPOINT 2 OPERATION MODE

Select 4 operation criteria of the setpoint 2 in sequence:

- NET*      The relay output is active in Net Weight mode  
*GROSS*    The relay output is active in Gross Weight mode  
*PEAK*      The relay output is active in Peak mode  
 Default: *GROSS*

Comparison with the net weight, gross weight or the peak. In this last case, the comparison is made with the last peak value acquired, even when the peak function is not active.

- N.O.*        The relay 2 is normally open  
*N.C.*        The relay 2 is normally closed  
 Default *N.O.*

- POS.*        The output is operating with positive weight  
*NEG.*        The output is operating with negative weight  
 Default: *POS*

- NORML*    Output 2 is active with unstable weight  
*STABL*     Output 2 is active with stable weight  
 Default: *Norml*

## HYST-2 HYSTERESIS OF THE SETPOINT 2

Hysteresis value than the setpoint value set

- Value: from 0 to 999  
 Default: 2

## t INEr 2 SETPOINT 2 TEMPORIZATION

Value of time, in tenths of a second, during which, when the weight value set is overcome, the output relative to setpoint 2 remains enabled.

After this time, even if the weight value is still above the setpoint, the output is automatically disabled.

The function is not activated if the programmed time is equal to zero.

- Value: from 0 to 999  
 Default: 0

## dELAY2 SETPOINT 2 DELAY

Value of time, in tenths of a second, after which, when the weight value set is overcome, the output relative to setpoint 2 remains enabled.

The function is not activated if the programmed time is equal to zero.

- Value: from 0 to 999  
 Default: 0

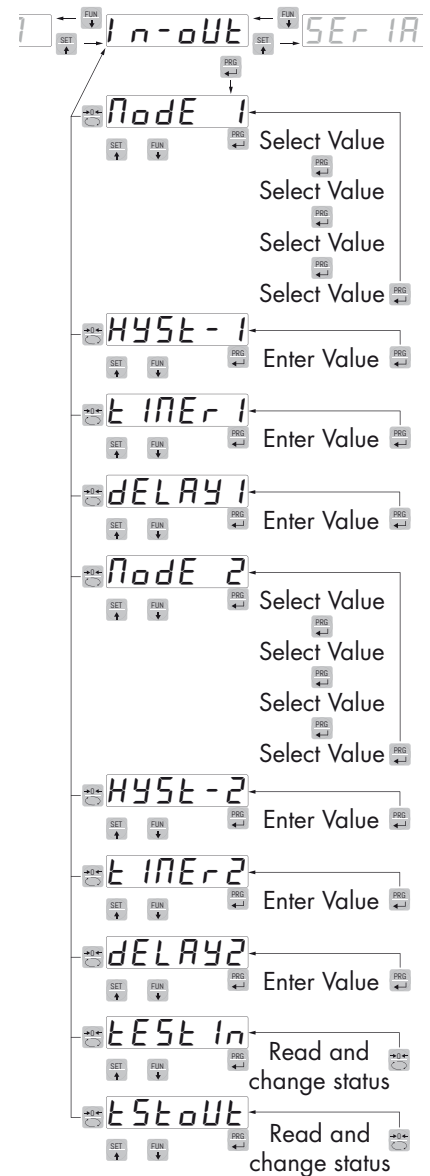

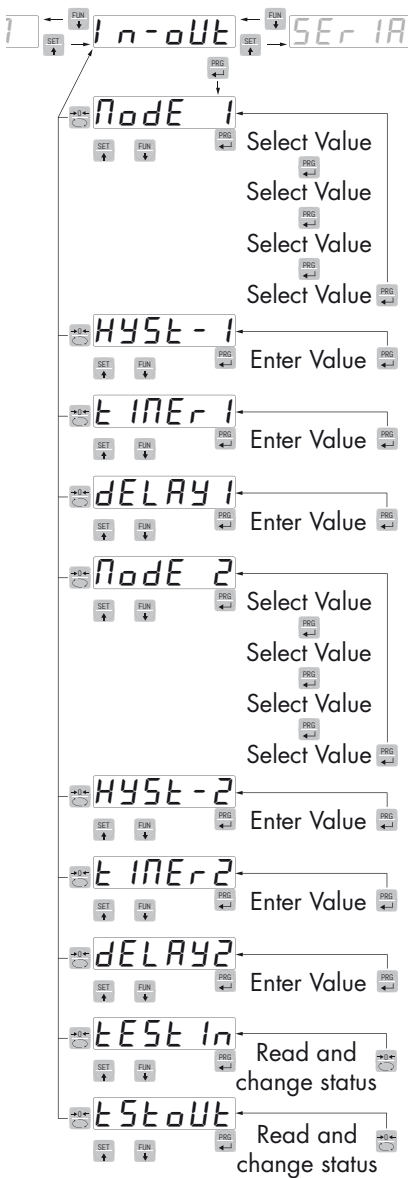

**tEst In LOGIC INPUTS TEST PROCEDURE**

The display shows the inputs status.

0 = input disabled

1 = input activated.

The input 1 corresponds to the 1<sup>st</sup> value on the left.

Enable and disable the inputs to check the corresponding state on the display. During this procedure, the normal function of the inputs is not active. Use this procedure only to check the hardware.

**tEstOut LOGIC OUTPUTS TEST PROCEDURE.**

The display shows the outputs status.

0 = output disabled, 1 = output activated.

The input 1 corresponds to the 1<sup>st</sup> value on the left.

During this procedure, the LEDs reflect the state of the outputs. To set the digits, use the keys as for the numeric settings.

During this procedure, the normal function of the outputs is not active. Use this procedure only to check the hardware.

# SERIAL OUTPUT PARAMETERS

This menu allows you to set the serial ports COM1 and COM2 and the communication parameters. The instrument has two independent serial ports:

COM1 with RS232 or RS422/RS485 interface

COM2 with optional FIELDBUS interface.

## BAUD r BAUD RATE COM1

It defines the baudrate of the RS232 serial port.

The value must be set to the same value of the PC / PLC or remote display.

Value to be selected:

2400

9600

19200

38400

115200

Default: 9600

## BAUD2r BAUD RATE COM2 (DEVICENET/CANOPEN VERSION)

It defines the baudrate of the DEVICENET or CANOPEN interface.

The value must be set to the same value of the PC/PLC.

Value to be selected:

125 250 500 DeviceNet

1SS, 20, 50, 125, 250, 500, 800, 1 M, AUTO Canopen

Default:

125 DeviceNet

500 Canopen

## Prot-1 COM1 PROTOCOL

It defines how to use the RS232 serial port

**None:** Serial communication OFF

**Contin:** Continuous transmission of the weight string. It can be used, for example, to drive a weight repeater. See details in the relevant paragraph.

**Demand:** When the Operator presses the front button or through Input 2, a string of weight is transmitted. The command is accepted if the weight is stable. Between two consecutive transmissions the weight must have a variation of at least 20 divisions.

**Autom-:** It's automatically transferred to a string of weight when the weight stabilizes at a value higher than the minimum weight (20 divisions). Between two consecutive transmissions, the weight must have a variation of at least 20 divisions.

**Slave:** ASCII protocol. See details in the relevant paragraph.

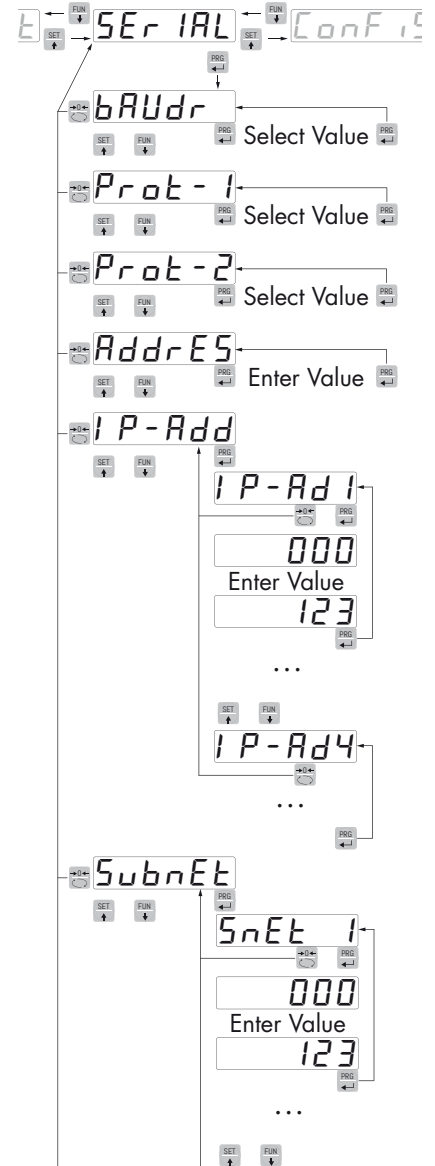

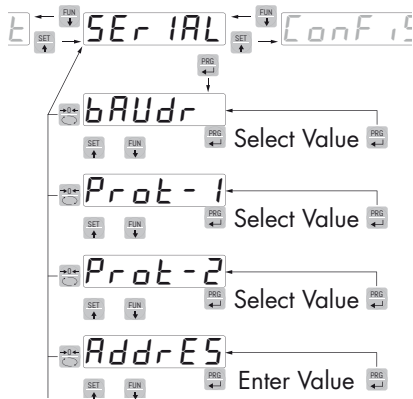

**Modbus:** MODBUS RTU (slave) protocol. used only if PROT-2 is configured equal NONE. See details in the relevant paragraph. Selectable communication parameters:

*n-8-1*

*n-8-2*

*E-8-1*

*o-8-1*

*Default: n-8-1*

**Print:** Data transfer to the printer.

*Value to be selected:*

*None*

*Contin*

*Demand*

*Autom-*

*Slave*

*Modbus*

*Print*

*Default: None*

#### *Prot-2* **COM2 PROTOCOL:**

It defines the Fieldbus use mode

**None:** Serial communication OFF

**PROFIB:** PROFIBUS fieldbus (if there is an optional board)

**DEVNET:** DEVICENET fieldbus (if there is an optional board)

**CANOPN:** CanOpen fieldbus (if there is an optional board)

**PROFNT:** PROFINET Fieldbus.

**ETH-IP:** ETHERNET IP Fieldbus

**ETHERN:** Ethernet fieldbus (if there is an optional board); the same protocol selected in PROT is handled with this type of interface. 1. To set the Ethernet module, see the relevant section.

*Value to be selected:*

*None*

*Profib*

*Devnet*

*Canopn*

*Profnt*

*Eth-IP*

*Ethern*

*Default:*

*None*

## AddrES COM1 SERIAL COMMUNICATION ADDRESS

Configuration of the address used in the transmission protocols and in the MODBUS protocol.

Value from 000 to 99.

Default: 01

## Pr-Add PROGRAMMING OF THE PROFIBUS ADDRESS

Configuration of the address used in the PROFIBUS protocol.

Values: from 0 to 126

Default: 01

## dC-Add PROGRAMMING OF THE DEVICENET OR CANOPEN ADDRESS

Programming of the address used in DEVICENET or CANOPEN protocol.

Value: from 0 to 63

Default: 01

## IP-Add PROGRAMMING THE IP ADDRESS

The 4 bytes that define the IP address must be programmed in sequence. In IP-Ad1 enter via the SET e FUN pushbuttons the value of the first three digits of the address. Once you have confirmed the value with the PRG key, the display shows IP-Ad1 again. Use the SET and FUN keys to select IP-Ad2 Enter the value of the second group of numbers and repeat until complete insertion of the address.

Values: from 000 to 255

Default: 000

## SubnEt PROGRAMMING THE SUBNET MASK

The 4 bytes that define the subnet mask, must be programmed in sequence with the same methods used for the IP address programming.

Values: from 000 to 255

Default: 000

## dELAY DELAYED RESPONSE OF THE SLAVE AND MODBUS RTU COM1 PROTOCOLS

Indicative delay of the response string used in the SLAVE protocol. (expressed in 1/100 sec., max 1 sec).

This value is expressed in milliseconds and represents the delay with which the instrument sends the response to the request received from the master.

Value: from 0 to 999 msec

Default: 000

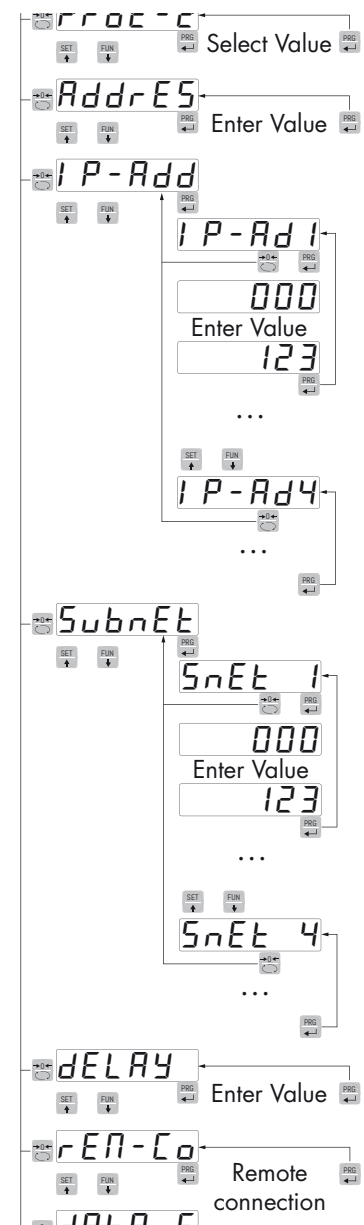

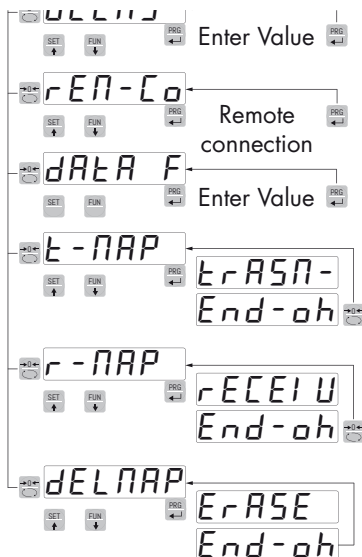

### *rEN-Co* **REMOTE COMMUNICATION**

It enables communication with a PC for the setting via the PC program

### *DATA F* **REMOTE COMMUNICATION**

Parameters of the serial COM1 protocols (parity, bits n., stop bits) except MODBUS.

### *t-NAP* **SENDING DATA TO THE PC**

This function allows to transfer the mapping of the registers from the DAT 400 instrument to the PC program. Before starting the transmission of the mapping, you should enable the reception of the map (Receive button) on the PC program. During transmission, the display of the instrument displays TRASM, at the end of the transmission it shows END-OK.

To end the mapping transferring process, press the key 0.

### *r-NAP* **RECEIVING DATA FROM THE PC**

This function allows to receive the registers mapping from the PC program.

Before starting the mapping transmission in the PC (Send key), the receiving function must be enabled on the DAT 400 by pressing the PRG key. When receiving, the display shows RECEIV, at the end of the receiving it shows END-OK. To end the process of mapping transferring, press the 0 key.

### *dELNAP* **DATA RESET**

This function allows you to restore the default mapping of the instrument, while restoring the default mapping of the instrument, ERASE is displayed.

# ANALOG - ANALOG OUTPUT PARAMETERS (DAT 400/A ONLY)

## F-SCALE FULL SCALE

It's the weight corresponding to the full scale of the analog output that can be different from the capacity of the weighting system.

Value to be set from 000 to 99999.

Default: the same value of the CAPACITY parameter

## MODE ANALOG OUTPUT OPERATION MODE

Selection of the value to be associated to the analog output, corresponding to the net weight, gross weight or the peak value.

Value to be selected:

NET

GROSS

PEAK

Default: GROSS

## ANZERO ZERO VALUE OF THE ANALOG OUTPUT

Analog value related to the full scale of the analog output to be subtracted.

## TEST ANALOG OUTPUT TEST PROCEDURE

With this procedure it is possible to check the operation of the analog output, causing the output value through the use of the keyboard.

The display shows the percentage of the output value than the full scale set.

Use the SET and  keys to increase/decrease the output value.

## RANGE ANALOG OUTPUT RANGE

Select the analog output range.

Value to be selected:

0÷20mA

4÷20mA

0÷10Vdc

0÷5Vdc

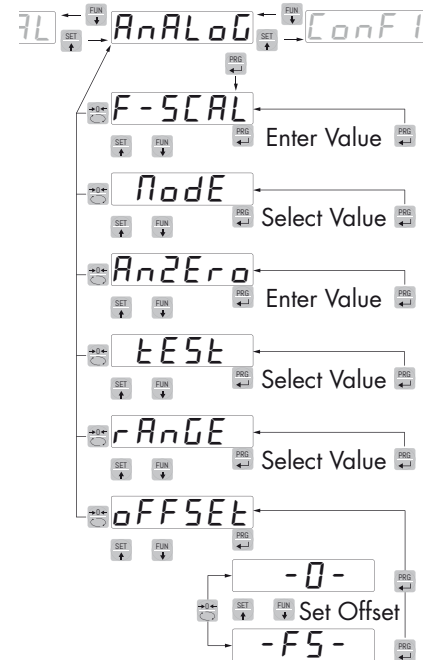

Default: 4÷20mA

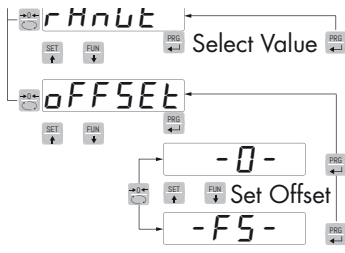





### Offset **ADJUSTING THE OFFSET (CALIBRATION)**

Measure the analog output value with a multimeter to perform the calibration of zero (0) and full scale (FS).

Use the  and  keys to adjust the analog output. Press and hold down the key for a rapid change.

Press the  key to toggle between offset of zero and that of full scale.

Press the  key to return to the OFFSET sub-menu. Press the  key to return to the ANALOG menu.



# SERIAL COMMUNICATION PROTOCOLS

## CONTINUOUS, AUTOMATIC AND MANUAL TRANSMISSION PROTOCOL

These protocols have been programmed into their programming menu.

The string is transmitted as follows:

STX	<status>	<net weight>	<gross weight>	<peak>	ETX	<chksum>	EOT
-----	----------	--------------	----------------	--------	-----	----------	-----

Where

STX (start of text) = 0x02h

ETX (end of text) = 0x03h

EOT (end of transmission) = 0x04.

<status> = an ASCII character that can take the following values:

"S" = stable weight.

"M" = weight that is not stable (moving).

"O" = weight greater than the maximum capacity.

"E" = weight that cannot be detected.

<net weight> = field consisting of 6 ASCII characters of net weight.

<gross weight> = field consisting of 6 ASCII characters of gross weight.

<peak> = field consisting of 6 ASCII characters of peak.

<chksum> = 2 ASCII control characters calculated considering the characters between STX and ETX excluded. The control value is obtained by executing the operation of XOR (or exclusive) of the 8-bit ASCII codes of the characters considered. The result is a character that is expressed in hexadecimal with 2 digits that can take values from "0" to "9" and "A" to "F".

<chksum> is the ASCII encoding of the two hexadecimal digits.

*In the case of continuous communication protocol, the given string is transmitted at a frequency of 10 Hz, regardless of the weight filter selected.*

*In the case of automatic and manual communication protocols, between 2 weight transmissions, the weight must have a variation corresponding at least 20 divisions.*

## SLAVE TRANSMISSION PROTOCOL

LIST OF THE CONTROLS AVAILABLE:

- Request for the net and gross weight and current peak.
- Change in gross weight.
- Change in net weight.
- Command of reset or automatic calibration or peak reset.
- Programming the two setpoints of weight
- Requesting the programmed setpoints.
- Control of setpoints storage in permanent memory.

The unit connected to the instrument (typically a personal computer) acts as a MASTER and is the only unit that can start a process of communication.

The process of communication must be made by the transmission of a string by the MASTER, followed by a reply from the SLAVE concerned.

## CONTROLS FORMAT DESCRIPTION:

The double quotes enclose constant characters (observe upper and lower case); the <and> symbols contain variable numeric fields.

### REQUEST FOR THE NET AND GROSS WEIGHT AND CURRENT PEAK

Master: <Addr> "N" EOT

DAT 400: "N" <Addr> <status> <net> <gross> <peak> ETX <chksum> EOT

### CHANGE IN GROSS WEIGHT

Master: <Addr> "C" "L" EOT

DAT 400: <Addr> "C" "L" ACK EOT

### CHANGE IN NET WEIGHT

Master: <Addr> "C" "N" EOT

DAT 400: <Addr> "C" "N" ACK EOT

### COMMAND OF RESET OR AUTOMATIC CALIBRATION OR PEAK RESET

Master: <Addr> "A" "A" EOT

DAT 400: <Addr> "A" "A" ACK EOT

### PROGRAMMING TWO WEIGHT SETPOINTS

Master: <Addr> "S" <s1> <s2> ETX <csum> EOT

DAT 400: <Addr> "S" ACK EOT

### REQUESTING FOR THE PROGRAMMED SETPOINT

Master: <Addr> "R" EOT

DAT 400: <Addr> "R" <s1> <s2> ETX <csum> EOT

### STORING THE WEIGHT Setpoint IN A PERMANENT MANNER

Master: <Addr> "M" EOT

DAT 400: <Addr> "M" ACK EOT

In the case of communication error or otherwise unrecognized command from DAT 400, it will respond with the following string:

DAT 400: <Addr> NAK EOT

## FIELDS DESCRIPTION

The double quotes enclose constant characters (observe upper and lower case); the <and> symbols contain variable numeric fields.

<addr> = Serial communication address of the instrument; it is the ASCII character obtained by adding 80h to the number of address (i.e. address 1: <Addr> = 80h + 01h = 81h).

<csum> = checksum of the string data. It is calculated by performing the exclusive OR (XOR) of all characters from <Addr> to ETX excluded the latter; the result of the XOR is decomposed into 2 characters by considering separately the upper 4 bits (first character) and lower 4 bits (second character); the 2 characters obtained are then ASCII encoded (example: XOR = 5Dh; <csum> = "5Dh" namely 35h and 44h).

ETX (end of text) = 0x03h,

EOT (end of transmission) = 0x04h,

ACK (acknowledgment) = 0x06h,

NAK (No acknowledgment) = 0x15h.

<status> = an ASCII character that can take the following values:

"S" = stable weight

"M" = weight that is not stable (moving)

"O" = weight greater than the maximum capacity

"E" = weight that cannot be detected.

<s1>...<s2> = 6 ASCII characters of setpoint.

<net weight> = 6 ASCII characters of net weight.

<gross weight> = 6 ASCII characters of gross weight.

<peak> = 6 ASCII characters of peak.

If the request is made cyclically, the weight is acquired with a maximum frequency of:

<b>Frequency</b>	<b>Baud Rate</b>
200Hz	115200
50Hz	38400
35Hz	19200
25Hz	9600
8Hz	2400

## MODBUS RTU PROTOCOL

The addresses listed in the tables below follow the standard address specified in the guidelines of the Modicon PI-MBUS-300. Below please find an excerpt that helps the user to communicate with the instrument.

*“All data addresses in Modbus messages are referenced to zero. The first occurrence of a data item is addressed as item number zero. For example:*

*The coil known as ‘coil 1’ in a programmable controller is addressed as coil 0000 in the data address field of a Modbus message.*

*Coil 127 decimal is addressed as coil 007E hex (126 decimal).*

*Holding register 40001 is addressed as register 0000 in the data address field of the message. The function code field already specifies a ‘holding register’ operation. Therefore the ‘4XXXX’ reference is implicit.”*

To confirm a new value in E2prom, run the function of MAKE – BACKUP. If this function is not performed by switching off, the DAT will return to the value before the change.

If not specified otherwise, the numerical values (such as addresses, codes and data) are expressed as decimal values.

For any hardware configuration of the instrument (FIELDBUS or Analog), the MODBUS RTU protocol is always available on COM1 RS232; in the event of Fieldbus absence, the MODBUS RTU protocol is also available on COM2 RS485.

## INSTRUMENT RESPONSE TIMES

In order to respond to most requests, the instrument takes a maximum time of 20 msec.

Exceptions are:

- the e2prom Backup command (max time = 350mSec.)
- writing of the registers of the cells capacity, cells sensitivity, net weight, system calibration, filter (max time = 550mSec).

## COMMUNICATION ERRORS HANDLING

The communication strings are controlled by the CRC (Cyclic Redundancy Check). In the case of a communication error, the slave does not respond with a string. The master must consider a timeout for the receipt of the response. In case of no answer, a communication error has occurred.

## RECEIVED DATA ERROR HANDLING

In the case of string received correctly, but that cannot be executed, the slave responds with an EXCEPTION RESPONSE according to the following table.

Code	Description
1	ILLEGAL FUNCTION (The function is not valid or not supported)
2	ILLEGAL DATA ADDRESS (The address of the specified data is not available)
3	ILLEGAL DATA VALUE (The received data have invalid value)

## SUPPORTED FUNCTIONS

Function	Description
01	READ COIL STATUS (Reading the state of the logic outputs)
02	READ INPUT STATUS (Reading the state of the logic inputs)
03	READ HOLDING REGISTERS (Reading the programmable registers)
04	READ INPUT REGISTERS (Reading the "read only" registers")
05	FORCE SINGLE COIL (Writing the status of each output)
06	PRESET SINGLE REGISTER (Writing a programmable register)
15	FORCE MULTIPLE COILS (Multiple writing of outputs)
16	PRESET MULTIPLE REGISTERS (Multiple writing of registers)
Funct + 80h	EXCEPTION RESPONSE

## LIST OF THE MODBUS PROTOCOL HOLDING REGISTERS

Address	Holding Register	R/W	Format	Note
40001	Status Register	R	INT	See table A
40002	Gross weight (MSB)	R	DINT	
40003	Gross weight (LSB)	R		
40004	Net weight (MSB)	R	DINT	
40005	Net weight (LSB)	R		
40006	Peak value (MSB)	R	DINT	
40007	Peak value (LSB)	R		
40008	Load cell signal in mV/V	R	INT	
40009	Logic inputs	R	INT	LSB = Input 1
40010	Output	R/W	INT	LSB = Output 1 (it writes only if the setpoint = 0)
40011	Keys status	R	INT	See table B, even if the key lock is enabled
40012	Firmware code and version	R	INT	See table C
40201	Setpoint 1 (MSB)	R/W	DINT	
40202	Setpoint 1 (LSB)	R/W		
40203	Setpoint 2 (MSB)	R/W	DINT	
40204	Setpoint 2 (LSB)	R/W		
40501	Data Register (MSB)	W	DINT	Data related to the Command Register
40502	Data Register (LSB)	W		
40503	Command Register	W	INT	See table D
41001	Cells capacity (MSB)	R/W	DINT	
41002	Cells capacity (LSB)	R/W		
41003	Cells sensitivity	R/W	INT	
41004	Weight division value	R/W	INT	See table E
41005	Tare of the system (MSB)	R/W	DINT	
41006	Tare of the system (LSB)	R/W		
41007	System capacity (MSB)	R/W	DINT	
41008	System capacity (LSB)	R/W		
41101	Weight filter	R/W	INT	0-9
41102	Weight stability	R/W	INT	0-4
41103	Auto-zero setpoint in % (MSB)	R/W	DINT	0-100%.
41104	Auto-zero setpoint in % (LSB)	R/W		
41105	Zero tracking	R/W	INT	0-4
41106	Zero band in divisions	R/W	INT	
41201	Operation mode Set 1	R/W	INT	See table F
41202	Hysteresis Set 1 (MSB)	R/W	DINT	
41203	Hysteresis Set 1 (LSB)	R/W		
41204	Timer Set 1	R/W	INT	
41205	Delay Set 1	R/W	INT	
41206	Operation mode Set 2	R/W	INT	See table F
41207	Hysteresis Set 2 (MSB)	R/W	DINT	
41208	Hysteresis Set 2 (LSB)	R/W		
41209	Timer Set 2	R/W	INT	
41210	Delay Set 2	R/W	INT	
41401	Analog full scale (MSB)	R/W	DINT	
41402	Analog full scale (LSB)	R/W		
41403	Analog mode	R/W	INT	See table G
41404	Analog range	R/W	INT	See table H
41405	Analog output value	R/W	INT	Points of analog output (da 0 a 65535). Analog output uses this value only if FS (41402) = 0
42000	Monitor Register	W	INT	The programmed value is automatically copied to Monitor Register R (42100)
42100	Monitor Register	R	INT	Copy of the value entered in Monitor Register W (42000)

**TABLE A - REGISTER STATUS CODING**

BIT	13	12	11	10	9	8	6	5	4	3	2	1	0
Description	Output 2	Output 1	Input 2	Input 1	Memory Flag	Lock keyboard	Off Range	Over-load	Under-load	Tare entered	Zero band	Stable weight	Zero center

WARNING: Bits 15, 14 and 7 are not managed and are always equal to 0.

OPERATION Flag memory (bit 9): When modifying a register that requires saving in the E<sup>2</sup>prom (see table "Data stored in memory with the command 0x020" on the next page), this bit is set to 1 to remind the user to run the command 0x0020 (saving data in the permanent memory). After performing this operation, the bit is automatically reset to zero.

OPERATION Bit related to a weight error (bit 6 of the STATUS REGISTER) When the cell is disconnected or the measured values are out of range, this bit is set to 1.

OPERATION Bit related to the Band of zero (bit 2 of the STATUS REGISTER) When the gross weight is less than or equal to the parameter "Band of zero in divisions", bit 2 of the status register is set to 1.

**TABLE B - KEYS CODING (40011)**

bit	Keys Status
0	SET key
1	FUN key
2	0 key
3	PRG key

WARNING: Bits 4 to 15 are not managed and are always equal to 0.

**TABLE C - FIRMWARE CODING**

bit	Firmware Code
0...7	Version code
8...15	Firmware code

**TABLE D- COMMAND REGISTER CODING TABLE FOR MODBUS PROTOCOL**

Register value	Command Register Function
0x0000	No command
0x0001	Semiautomatic zero
0x0002	Autotare
0x0003	Peak reset
0x0010	Calibration of the weight zero
0x0011	Calibration of the full weight scale
0x0020	Saving the data in the permanent memory
0x7FFF	Direct access to memory

**TABLE E- CODING DIVISION VALUE**

Register value	0	1	2	3	4	5	6	7	8
Division value	0.001	0.002	0.005	0.00	0.02	0.05	0.1	0.2	0.5

Register value	9	10	11	12	13	14
Division value	1	2	5	10	20	50

Addr. of Modbus register	Data stored in memory with the 0x0020 command
41001-41002	Cells capacity
41003	Cells sensitivity
41004	Weight division value
41005-41006	Tare of the system
41007-41008	System capacity
41101	Weight filter
41102	Weight stability
41103-41104	Auto-zero setpoint
41105	Zero tracking
41106	Zero band in divisions
41201	Operation mode Set 1
41202-41203	Hysteresis Set 1
41204	Timer Set 1
41205	Delay Set 1
41206	Operation mode Set 2
41207-41208	Hysteresis Set 2
41209	Timer Set 2
41210	Delay Set 2
41401-41402	Analog full scale
41403	Analog mode
41404	Analog range

**TABLE F - WEIGHT SETPOINT OPERATION CODING**

bit	Setpoint operation mode
0...1	0 = Net weight, 1 = Gross weight, 2 = Peak
2	0 = N.O. 1 = N:C.
3	0 = Positive values 1 = Negative values
4	0 = Always controlled 1 = Only with stable weight

**TABLE G - CODING ANALOG OUTPUT**

Value	Analog output mode
0	Net weight
1	Gross weight
2	Peak

**TABLE H - CODING ANALOG OUTPUT**

Value	Analog output range
0	0÷20 mA
1	4÷20 mA
2	0÷10 V
3	0÷5 V

**EXAMPLE: CALIBRATION FUNCTION VIA MODBUS**

To perform the calibration of full scale (that require the weight value in the sample set in the data register), the value in the data register must be present when the command register is programmed. For example:

Calibrate the full scale using a sample weight of 2000 kg.

Write 2000 in the data register.

Write 0x0011 in the command register.

Use the multiple registers write function and write the registers of data register and command register in a single command.



## PRINT PROTOCOL

This protocol enables the communication with a printer. The data on the printed report are the following: NET, GROSS and TARE (+ PEAK, if enabled).

The print command takes place by pressing the  key or by activating the remote input #2. (\*)

The printed report is issued only if the following conditions are met:

- Gross weight positive
- Net weight positive
- Stable weight (\*\*)
- BLIND function disabled (\*\*\*)

(\*) In case the  key is locked (see page 18) the print command can take place through the remote input #2 only.

(\*\*) The weight stability condition is controlled only if the "MOTION" parameter (see page 28) is set to a value different than 0.

If MOTION = 0 the printed report is issued even if the weight is unstable.

(\*\*\*) In case the BLIND function is enabled (see page 18) the print command can take place through the remote input #2 only, not via the  key.

Between one printout and the next one the weight must change for at least 20 counts.

## CONNECTION TO THE PRINTER

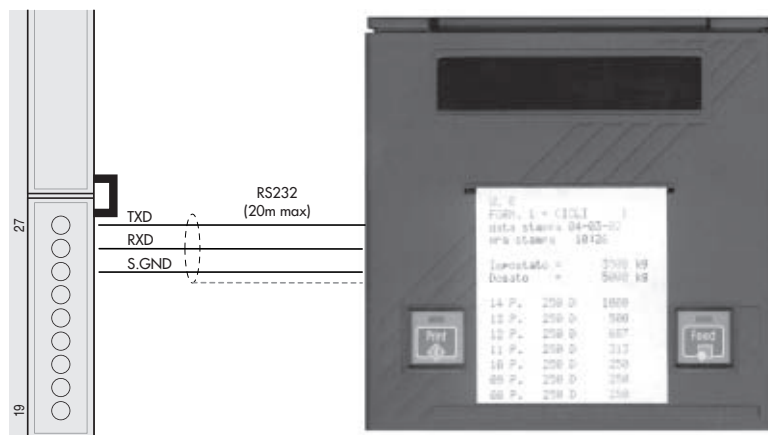

## PRINTED REPORT FORMATS

Standard		Peack enabled	
Net	9.488 kg	Net	9.488 kg
Gross	19.874 kg	Gross	19.874 kg
Tare	10.386 kg	Tare	10.386 kg
		Peak	35.294 kg

## **THE USB CONNECTION BETWEEN THE DAT-400 AND THE PC**

The hardware module installed inside the DAT-400 and allowing the instrument to be interfaced with a PC through the USB port, is named CP210x, manufactured by Silicon Laboratories.

The CP210x module needs the drivers to be installed in the PC:

By installing on PCs the INNOVATION 2 utility software drivers will be loaded automatically. For installation refer to the manual.

# ETHERNET INTERFACE CONFIGURATION

To configure the Ethernet interface it is necessary to use the PC application " TCPBridge Configurator" supplied with the instrument. To install the application, run the "setup.exe" file and follow the installation wizard.

Connect the DAT 400 to the PC according to the two procedures:

1. Direct connection by using special ethernet cable called "cross" or "crossover".



2. Connection to a LAN Network (Local Area Network ) using ethernet "direct" cables . In this case, the instrument must be connected to a network device (router , switch or hub ) to access the LAN.

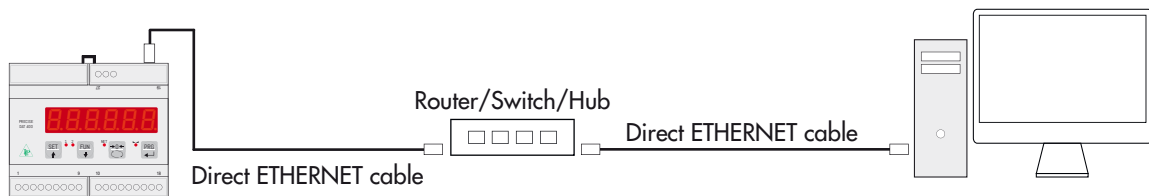

From the Programs menu, select the application " Configurator " , under " TCPBridge Configurator" .

You will see the screen as shown in the image here.

It may not be possible to immediately establish a connection with DAT 400/Ethernet. This may be due to an incompatibility between the programmed IP address by default on DAT 400/Ethernet LAN and the network in which the device is installed for the first time. The IP addresses of devices on a LAN must adhere to a certain format. Check in the PC "network connection" (Control Panel -> Network Connections) the format of your IP address.

To configure the Ethernet interface of the instrument DAT 400, follow the steps below.

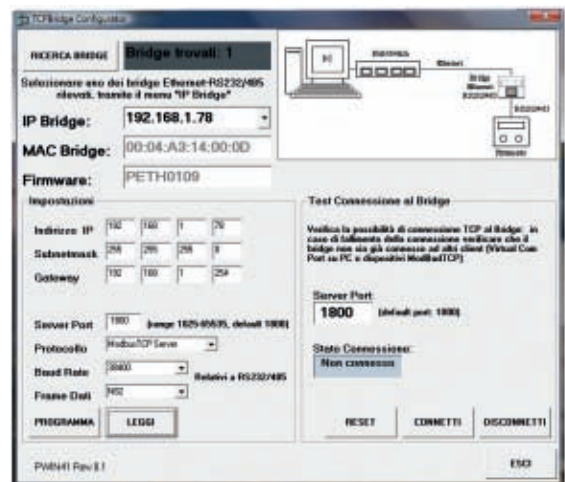

## SEARCH DEVICES

RICERCA BRIDGE **Bridge trovati: 1**

Selezionare uno dei bridge Ethernet-RS232/485 rilevati, tramite il menu "IP Bridge"

IP Bridge: 192.168.0.150

MAC Bridge: 00:04:A3:00:00:01

Firmware: PETH0109

To perform a search for devices DAT 400/Ethernet on the network, press the "RICERCA BRIDGE". Each device detected in the network can be selected from the drop down "IP Bridge" menu; in addition to that by selecting a specific device, it displays its MAC address and the version of the firmware loaded on the device.

Select the device you want to configure.

To avoid communication problems, the application buttons are disabled during the search of the devices.

Impostazioni

Indirizzo IP: 192 168 1 70

Subnetmask: 255 255 255 0

Gateway: 192 168 1 254

Server Port: 1800 (range: 1025-65535, default 1800)

Protocollo: ModbusTCP Server

Baud Rate: 38400 Relativi a RS232/485

Frame Dati: NB2

PROGRAMMA LEGGI

## PARAMETERS CONFIGURATION

After selecting the device you want to configure, perform the function reading of the parameters currently programmed in the device. To perform this function, use the "LEGGI" key, after a few seconds the configurable parameters (see image at right) will be updated with the values stored in the device at the time of the request.

These are the programmable parameters:

- **IP Address:** address of the device DAT 400, four numerical values (values between 0 and 255, mandatory field).
- **Subnet Mask:** four numerical values (values between 0 and 255, this parameter can be omitted or set to 0).
- **Gateway:** four numerical values (values between 0 and 255, this parameter can be omitted or set to 0).
- **Server Port:** communication port for TCP / IP, numeric value between 1025 and 65535. This value has different meanings depending on the selected protocol:
  1. When the connection is established by other devices present in the network (eg a PC) to the DAT 400/Ethernet (TCP Server protocol or Modbus TCP Server protocol), the Server Port parameter indicates the "TCP port" on which a Client device (eg, a PC) may perform a TCP connection with DAT 400/Ethernet.
  2. When the connection is established from DAT 400/Ethernet to a particular device in the network (TCP Client), the Server Port parameter indicates the "TCP port" Device Server (for example, a PC in the network) on which DAT 400/Ethernet can establish a TCP connection.

*The TCP Client can only be used if PETH02 firmware is loaded in the Ethernet interface of the DAT 400/Ethernet instrument; check the firmware version after the search of the devices.*

- **Protocol:** the device can be configured to operate in three different modes:
  1. TCP Client: Select this protocol if you want that DAT 400/Ethernet (Client) establish as a connection to a particular device on the network (Server). In this case it is need an additional input parameter (Server IP), this parameter represents the IP address of the server to which DAT 400 must establish a TCP connection.

*The TCP Client can only be used if PETH02 firmware is loaded in the Ethernet interface of the DAT 400/Ethernet instrument; check the firmware version after the search of the devices.*
  2. TCP Server: Select this protocol if DAT 400/Ethernet (Server) must wait to receive TCP connections from other devices in the network (Client).
  3. Modbus TCP Server: Select this protocol if DAT 400/Ethernet (Server) must wait to receive TCP connections from other devices in the network (Client), which use the MODBUS TCP communication protocol.

- **BAUD RATE: THIS VALUE MUST ALWAYS BE SET TO 38400 BAUD.**
- **FRAME DATA: THIS VALUE MUST ALWAYS BE SET TO N-8-2.**

*The TCP Client can only be used if PETH02 firmware is loaded in the Ethernet interface of the DAT 400/Ethernet instrument; check the firmware version after the search of the devices.*

### TCP TEST CONNECTION

In case of "TCP Server" or "Modbus TCP Server" protocol, you can test the connection directly via the "TCPBridge Configurator" PC application (PWIN41). This function can not be performed in case of "TCP Client" protocol. Manually enter the "Server Port" parameter, or use the reading parameters function described on the previous page.

The "Server Port" parameter indicates the "TCP port" available by DAT 400/Ethernet (Server) on which the "TCPBridge Configurator" PC application (Client) can establish a TCP connection.

Press the "CONNECT" key to establish a TCP connection with DAT 400/Ethernet. The connection status is displayed in the "Stato Connessione" section. To end a TCP connection press the "DISCONNETTI" button.

DAT 400/Ethernet can accept and maintain only one connection; before the test of the connection make sure that other client devices in the network are not associated with DAT 400/Ethernet.

If the TCP connection test is successful (Stato Connessione: Connesso), the device DAT 400 is ready to be used. The communication protocol selected by parameter "COM-2" (refer on page 34) is available on the Ethernet interface of the device DAT 400.

The reset function of the ethernet interface of the instrument DAT 400 can be performed at any time (for example in case of problems during testing of the TCP connection or when programming parameters), using the appropriate "RESET" button. This function does not reset the instrument DAT 400, but only its Ethernet interface.



# FIELDBUS PROTOCOL

FIELDBUS data exchange takes place on two separate memory areas, which are described in the tables below.

## WARNING:

The "Input Data Area" and the "Output Data Area" are of 128 bytes

To transfer the parameters of the Output Data Area to the instrument you need to enable direct access to the memory, writing the hexadecimal value 0x7FFF in the Command Register (1 word in writing) in order to avoid that the instrument resets all its variables in the case of uninitialized Output Data Area

This command must be sent before the connection to inform the instrument that the parameters have been initialized by the master. Now, the instrument continually tests the changes made to the parameters and stores them only in case of real change.

## ETHERNET IP: LOGIX 5000 SOFTWARE PROCEDURE CONNECTION

1. eds file installation.
2. In the Tools menu of the RSLogix 5000 software, select "EDS Hardware Installation Tool" to perform installation of the .eds file provided with the instrument.

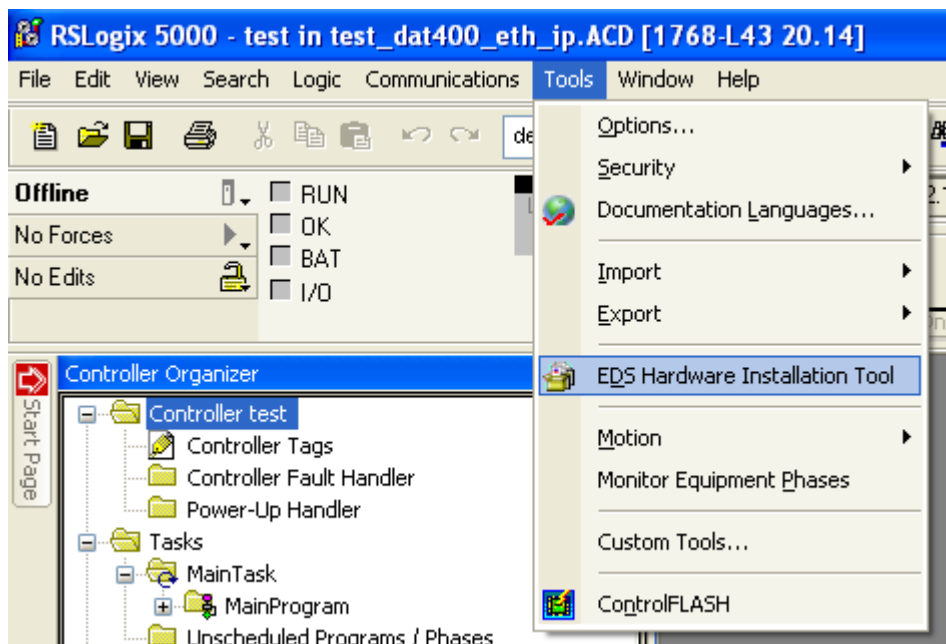

3. In the Controller Organizer window, I/O Configuration folder, choose the Ethernet subfolder click the right mouse button and select New Module.

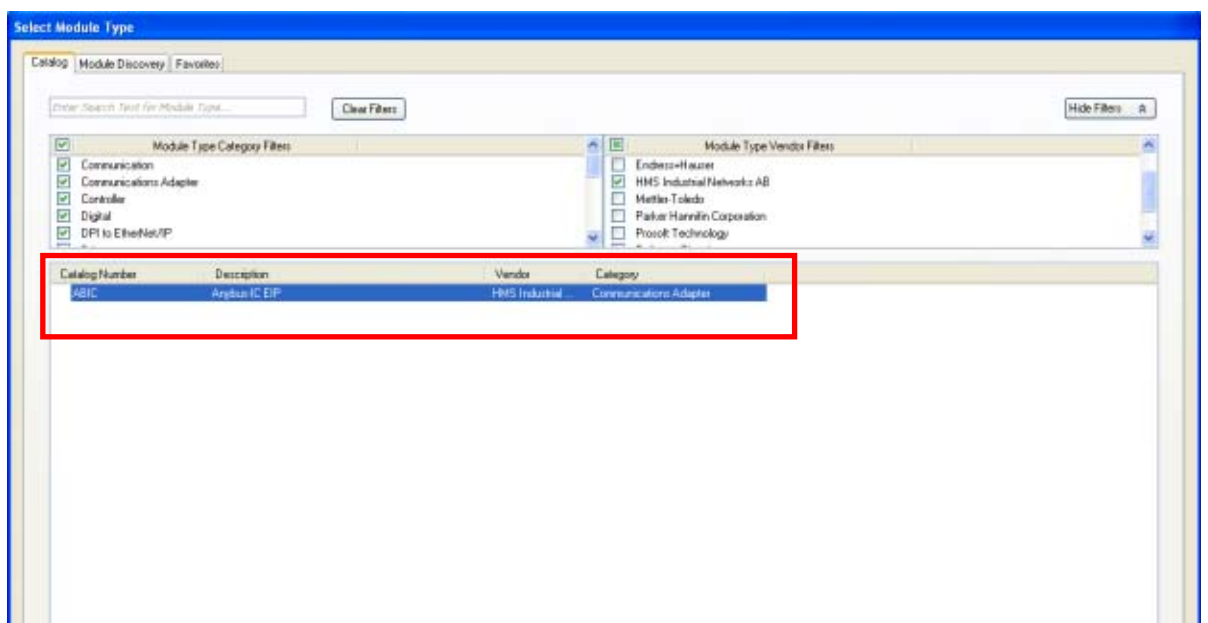
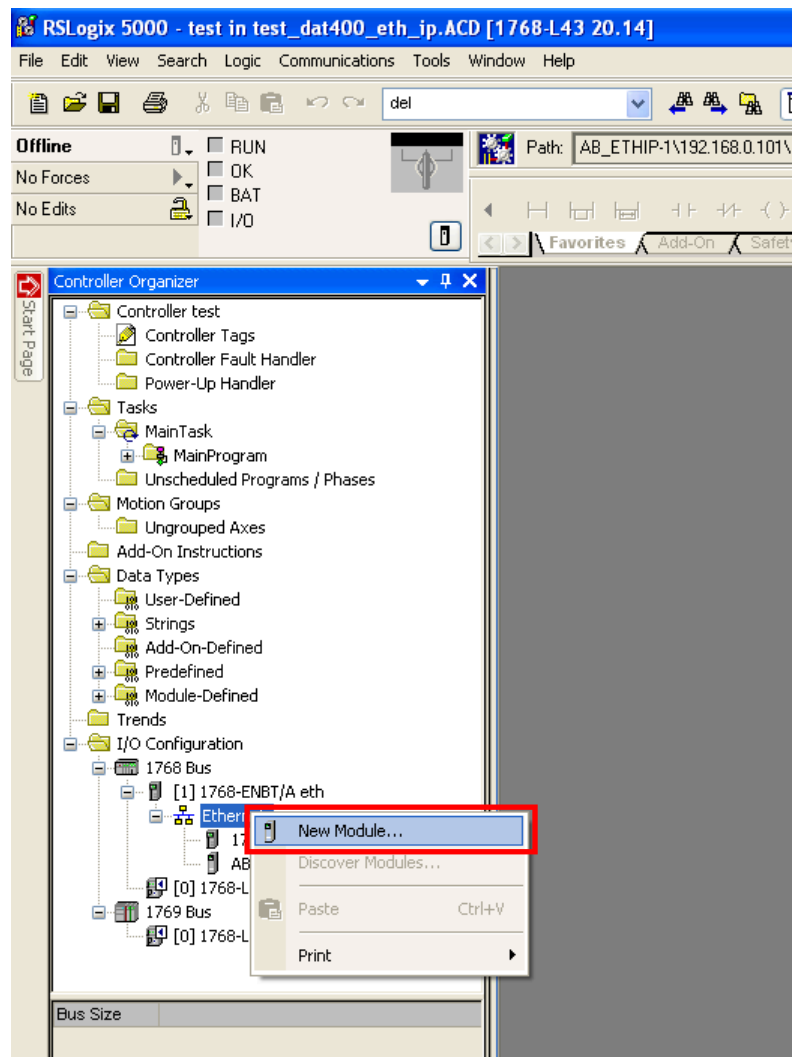

- Name the module with a desired name, enter the same IP address of the instrument, see page 35, as shown in the following figure.

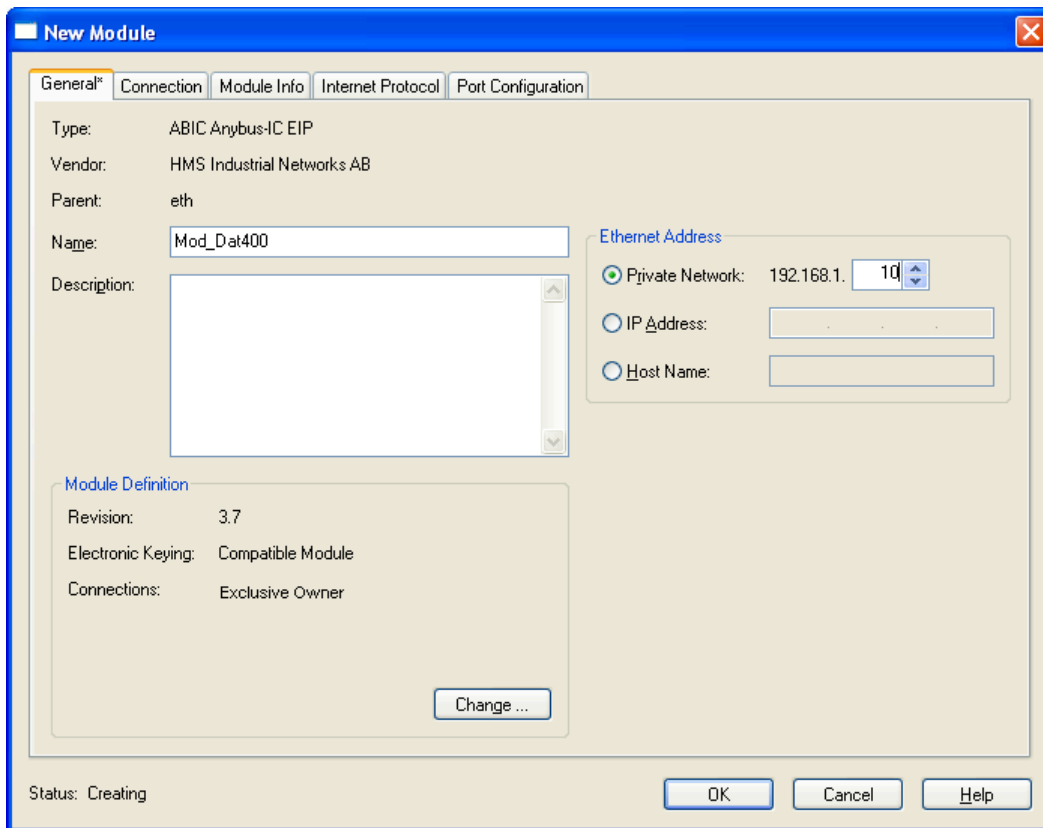

- Then select inputs and outputs at 128 byte in INTEGER mode.

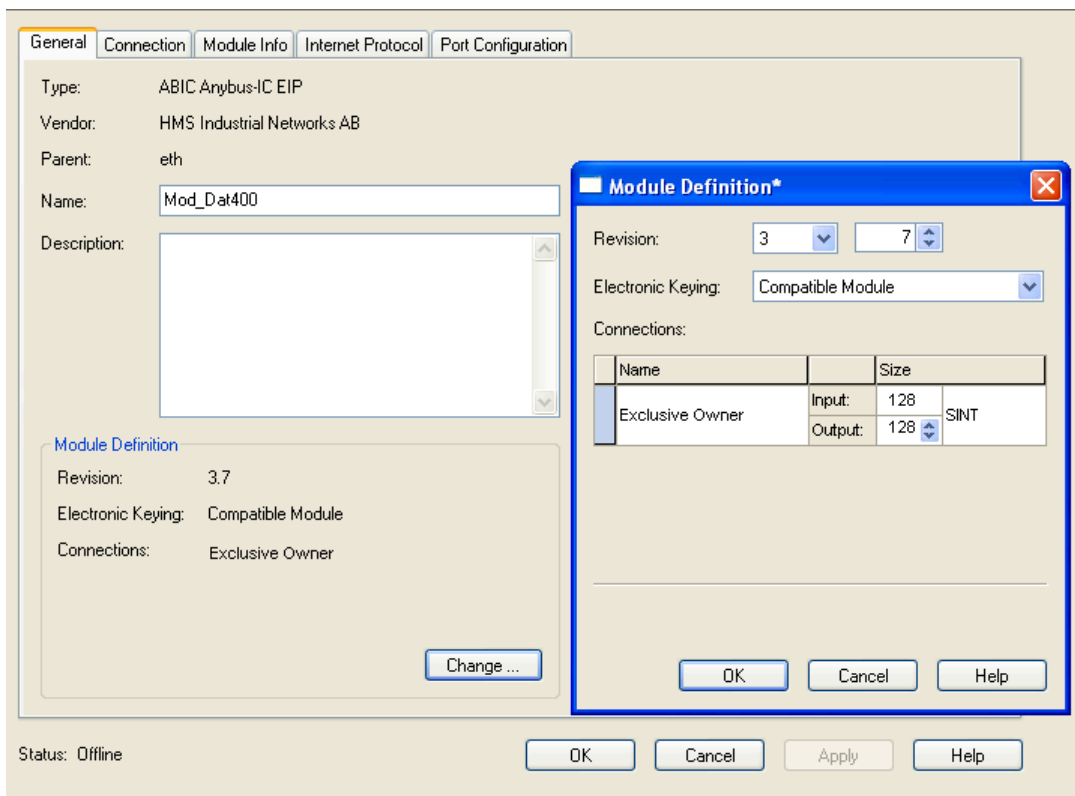



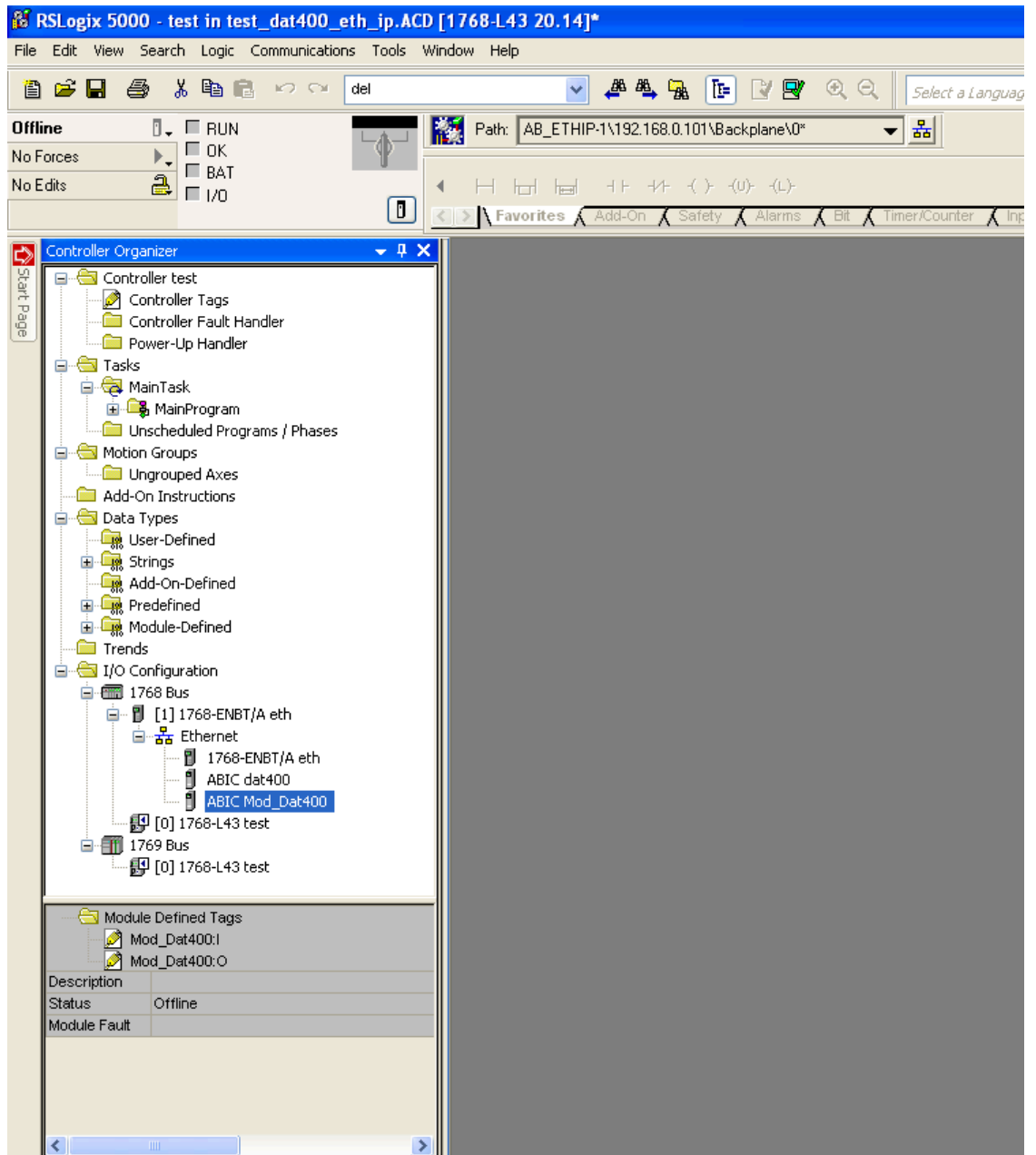

6. Through BOOTP-DHCP Server software, perform boot configuration. ETHERNET configuration is complete.

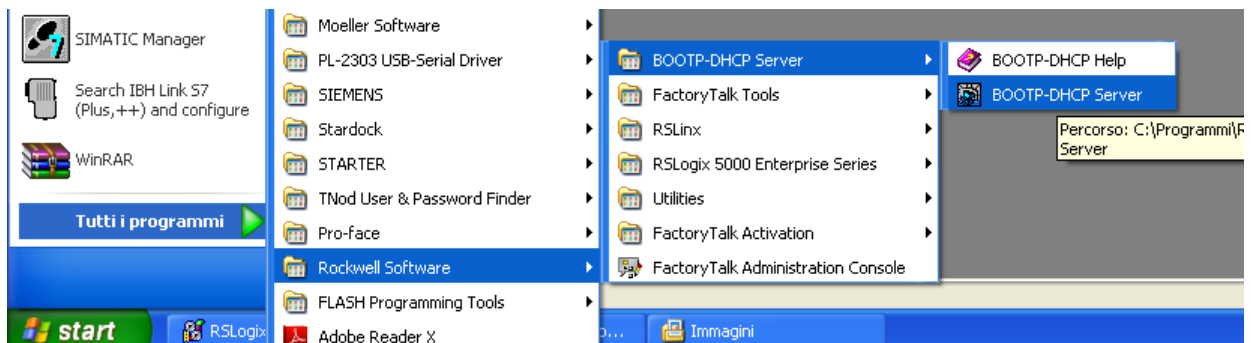

## PROFINET: S7 300 PROCEDURE CONNECTION

1. gsd file installation.

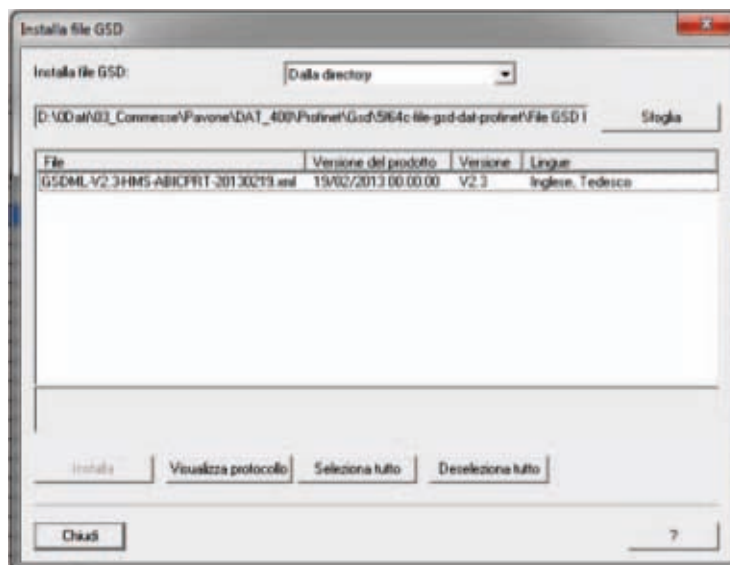

2. In the Siemens catalog, path Profinet IO, General, Anybus-IC PRT, select the standard RT module and add in the profinet network.

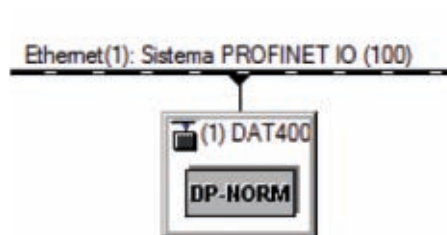

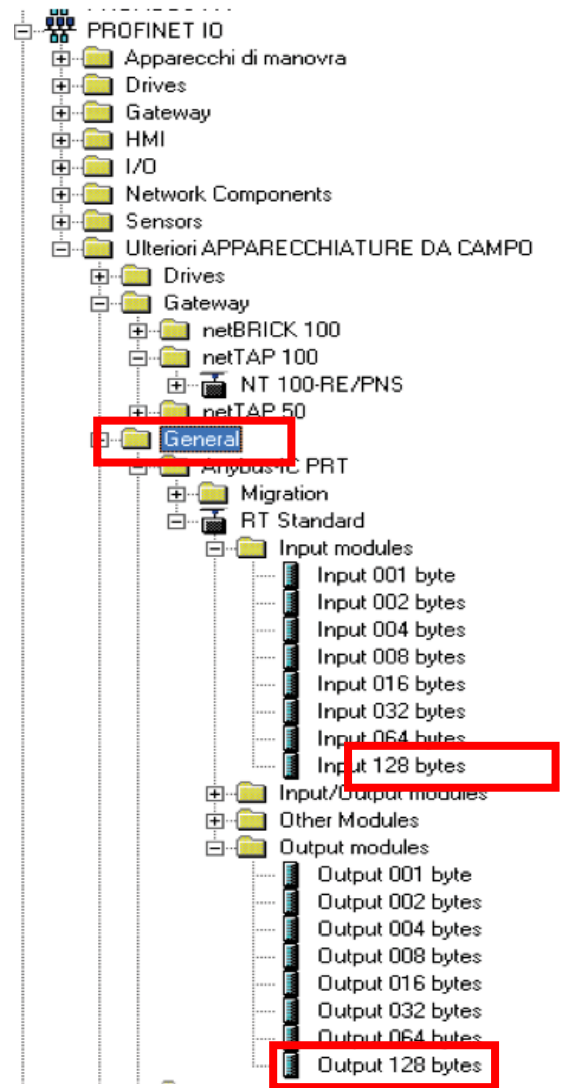

3. Enter inputs and outputs to 128 bytes and associate desired address, define the name of the object eg. DAT400, it will serve for naming the network.

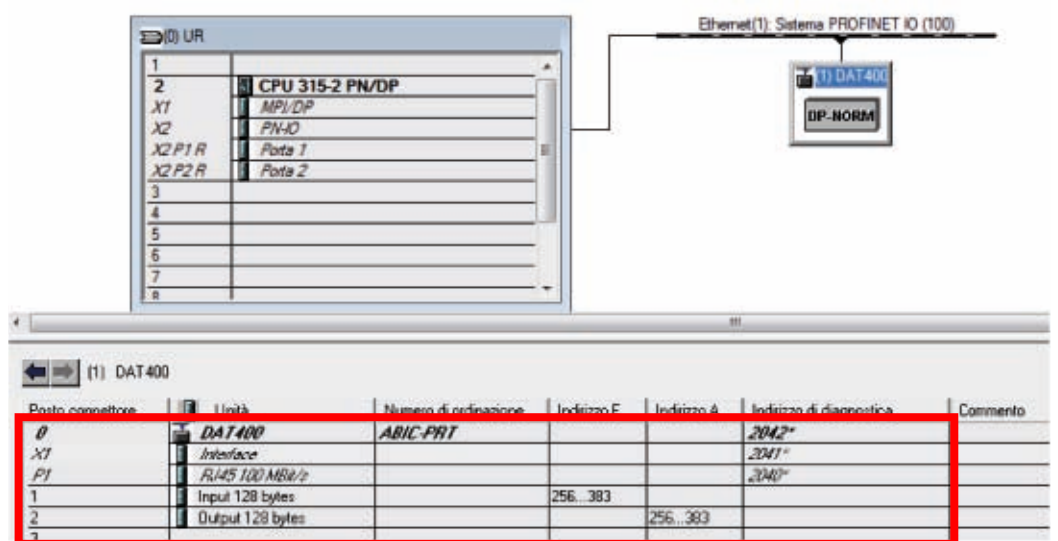

4. Open interface properties and change in the folder IO cycle the value of the number of cycles without updating data. If this value won't be not changed, the cpu will continue to generate communication errors and the module won't recognized on the network, or will continues to give communication errors.

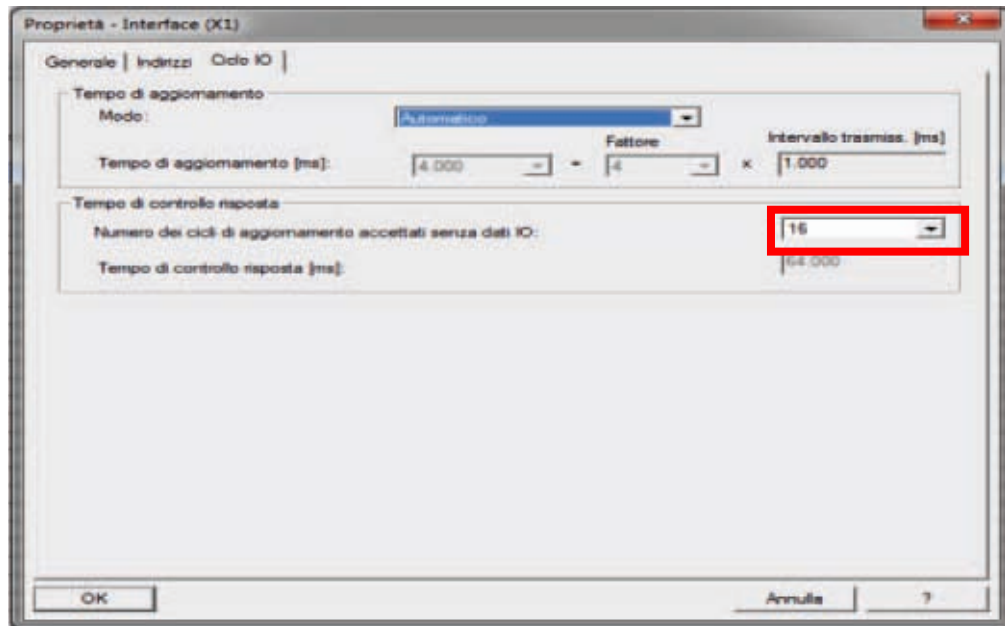

5. Select the procedure ethernet node editing.

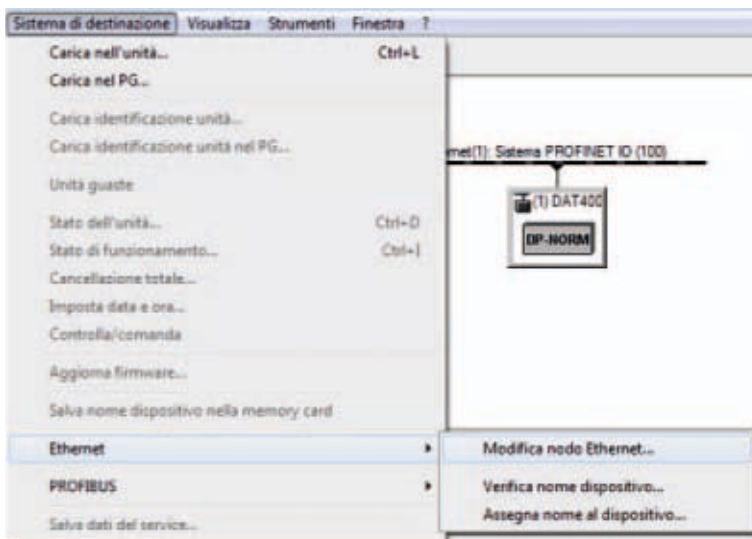

- Using the Browse button, select the module to be parameterized, define in the DAT 400 configuration the IP address, see PARAMETERS SERIAL OUTPUT. Give to the module the IP configuration and device name. The device name must be the same as defined in the hardware configuration DEVICE NAME; if the IP address and the NAME UNIT are not defined and equal, the module is not recognized in the PROFINET network.

Modifica del nodo Ethernet

Nodo Ethernet

Indirizzo MAC: 00-30-11-0C-32-38

Nodo raggiungibile online

Sfoglia...

Impostazione configurazione IP

Utilizzo parametri IP

Indirizzo IP: 192.168.0.100

Maschera sotto-rete: 255.255.255.0

Accoppiamento ad altra rete

Non utilizzare nessun router

Utilizza router

Indirizzo: 192.168.0.100

Rilevamento dell'indirizzo IP da un altro server DHCP

identificato tramite

ID client

Indirizzo MAC

Nome apparecchio

ID client:

Assegna configurazione IP

Assegnazione nome apparecchio

Nome apparecchio: dat400

Assegna nome

Reset delle impostazioni della fabbrica

Reset

Chiudi

?

# PROFINET: S7 1200 PROCEDURE CONNECTION

1. gsd file installation.

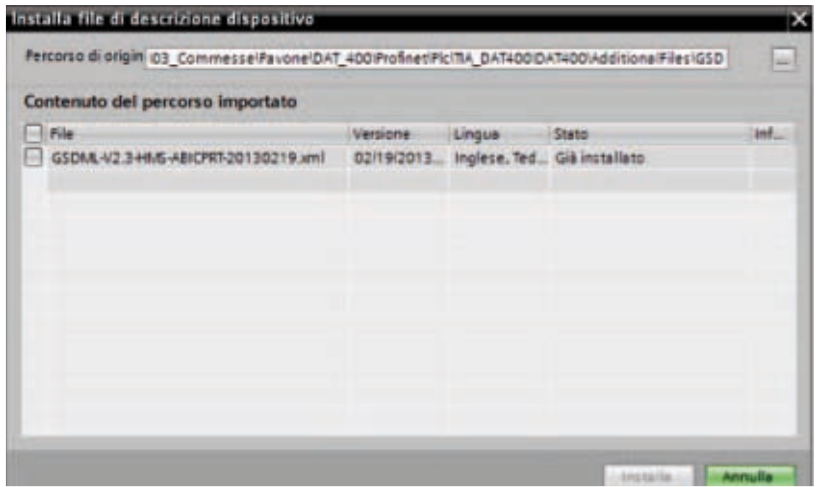

2. In the Siemens catalog, path Profinet IO, General, Anybus-IC PRT, select the standard RT module and add in the profinet network.

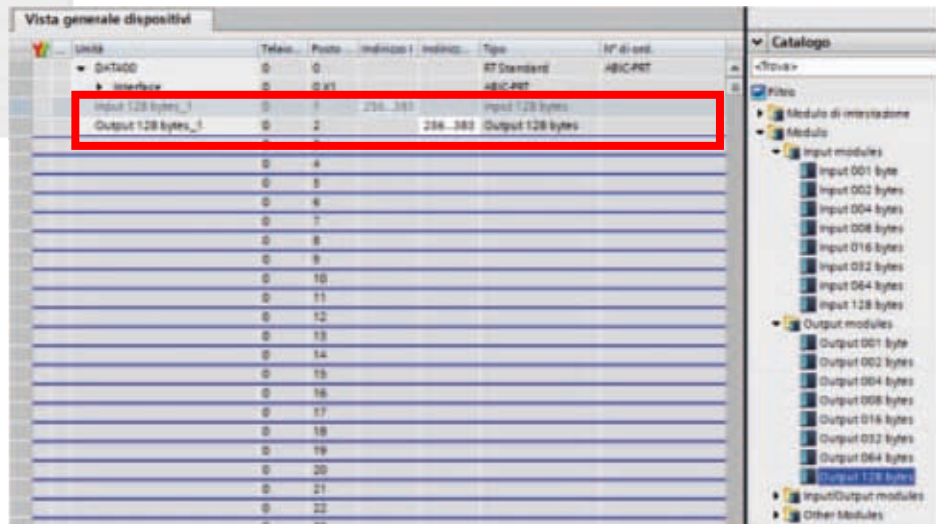
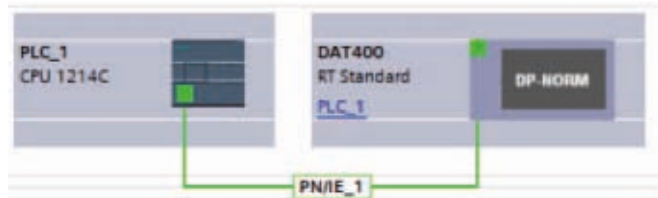
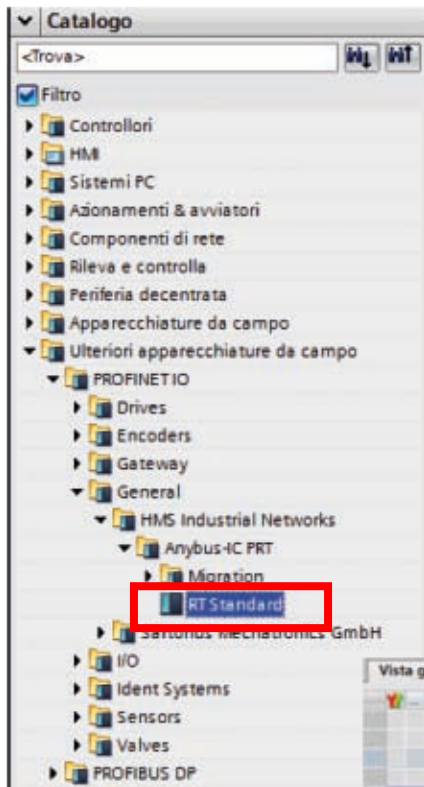

- Open interface properties and change in the folder IO cycle the value of the number of cycles without updating data. If this value won't be not changed, the cpu will continue to generate communication errors and the module won't recognized on the network, or will continues to give communication errors.

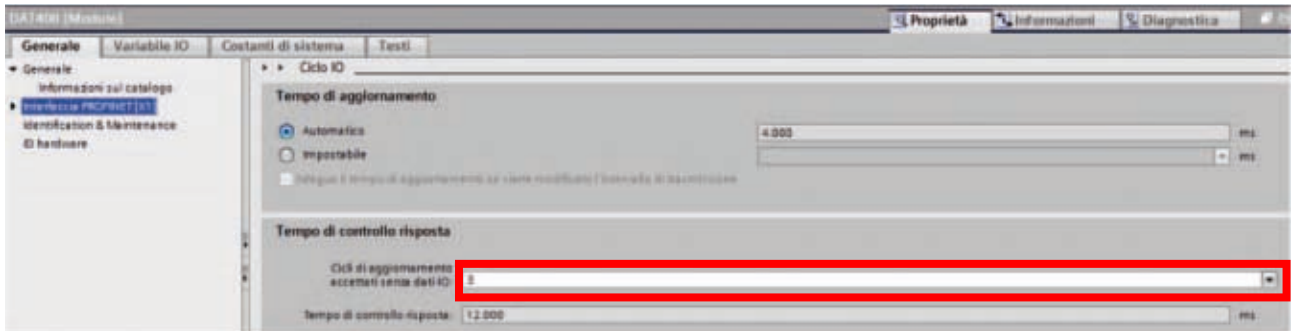

- Through assigns name to the device, select the module to be parameterized, define in the configuration of DAT 400 the IP address, see PARAMETERS SERIAL OUTPUT. Assign to the module the IP configuration and device name; The device name must be the same as defined in the hardware configuration DEVICE NAME. If the IP address and the NAME UNIT are not defined and equal, the module is not recognized in the profinet network.

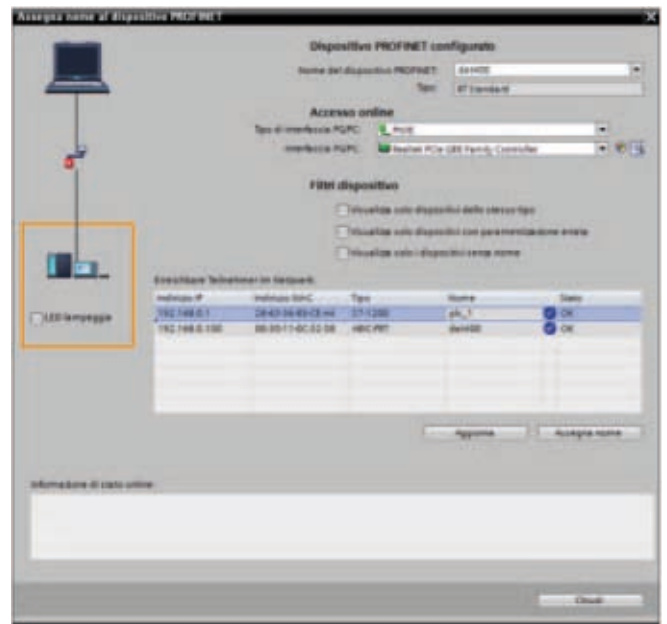

## INPUT DATA AREA

ADDRES		Description	Format	Note
Byte	Bit			
0	0	Keyboard_Look	BOOL	See table A Page 45
0	1	Memory_Flag	BOOL	See table A Page 45
0	2	Input_1	BOOL	See table A Page 45
0	3	Input_2	BOOL	See table A Page 45
0	4	Output_1	BOOL	See table A Page 45
0	5	Output_2	BOOL	See table A Page 45
0	6	Spare	BOOL	See table A Page 45
0	7	Spare_1	BOOL	See table A Page 45
1	0	Center_of_Zero	BOOL	See table A Page 45
1	1	Stable_Weight	BOOL	See table A Page 45
1	2	Zero_Band	BOOL	See table A Page 45
1	3	Tare_entered	BOOL	See table A Page 45
1	4	Under_Load	BOOL	See table A Page 45
1	5	Over_Load	BOOL	See table A Page 45
1	6	Off_Range	BOOL	See table A Page 45
2	0	Gross_Weight	DINT	
6	0	Net_Weight	DINT	
10	0	Peak_Weight	DINT	
14	0	Load_Cells_Signal_mV_V	INT	
16	0	Input_Status	INT	
18	0	Output_Status	INT	
20	0	Not used	BYTE	
21	0	SET_Key	BOOL	See table B Page 45
21	1	FUN_Key	BOOL	See table B Page 45
21	2	0_Key	BOOL	See table B Page 45
21	3	PRG_Key	BOOL	See table B Page 45
22	0	Cod_Firmware	BYTE	See table C Page 45
23	0	Cod_Versione	BYTE	See table C Page 45
24	0	SP_1	DINT	
28	0	SP_2	DINT	
32	0	Load_Cell_Capacity	DINT	
36	0	Load_Cell_Sensitivity	INT	
38	0	Weight_Division_Value	INT	
40	0	Tare_of_the_System	DINT	
44	0	Capacity_of_the_System	DINT	
48	0	Filter_Value	INT	
50	0	Weight_Stability_value	INT	
52	0	Autozero_Set	DINT	
56	0	Tracking_Factor	INT	



58	0	Zero_Band	INT	
60	0	Not used	BYTE	
61	0	Set_1_Net_Weight	BOOL	See table F Page 46
61	1	Set_1_Gross_Weight	BOOL	See table F Page 46
61	2	Set_1_NO_NC	BOOL	See table F Page 46
61	3	Set_1_Pos_Neg_Values	BOOL	See table F Page 46
61	4	Set_1_Control	BOOL	See table F Page 46
62	0	Set_1_Hysteresys	DINT	
66	0	Set_1_Timer	INT	
68	0	Set_1_Delay	INT	
70	0	Not used	BYTE	
71	0	Set_2_Net_Weight	BOOL	See table F Page 46
71	1	Set_2_Gross_Weight	BOOL	See table F Page 46
71	2	Set_2_NO_NC	BOOL	See table F Page 46
71	3	Set_2_Pos_Neg_Values	BOOL	See table F Page 46
71	4	Set_2_Control	BOOL	See table F Page 46
72	0	Set_2_Hysteresys	DINT	
76	0	Set_2_Timer	INT	
78	0	Set_2_Delay	INT	
80	0	Monitor_Register	INT	

### READING EXAMPLE

To read the gross weight on the DAT 400 it is needed to read the addresses from 2 to 5 of the Input Area.

To read the net weight it is needed to read the addresses from 6 to 9 of the Input Area.

When the display shows the gross weight value of 12351 in the corresponding bytes there will be:

	Byte 2	Byte 3	Byte 4	Byte 5
Hex	00	00	30	3F

## OUTPUT DATA AREA

Indirizzi		Descrizione	Formato	Note
Byte	Bit			
128	0	Command_Register	INT	See table D Page 45
130	0	Logic_Output	INT	
132	0	SP_1	DINT	
136	0	SP_2	DINT	
140	0	Data_Register	DINT	
144	0	Load_Cell_Capacity	DINT	
148	0	Load_Cell_Sensitivity	INT	
150	0	Weight_Division_Value	INT	See table E Page 45
152	0	Tare_of_the_System	DINT	
156	0	Capacity_of_the_System	DINT	
160	0	Filter_Value	INT	
162	0	Weight_Stability_value	INT	
164	0	Autozero_Set	DINT	
168	0	Tracking_Factor	INT	
170	0	Zero_Band	INT	
172	0	Not used	BYTE	
173	0	Set_1_Net_Weight	BOOL	See table F Page 46
173	1	Set_1_Gross_Weight	BOOL	See table F Page 46
173	2	Set_1_NO_NC	BOOL	See table F Page 46
173	3	Set_1_Pos_Neg_Values	BOOL	See table F Page 46
173	4	Set_1_Control	BOOL	See table F Page 46
174	0	Set_1_Hysteresys	DINT	
178	0	Set_1_Timer	INT	
180	0	Set_1_Delay	INT	
182	0	Not used	BYTE	
183	0	Set_2_Net_Weight	BOOL	See table F Page 46
183	1	Set_2_Gross_Weight	BOOL	See table F Page 46
183	2	Set_2_NO_NC	BOOL	See table F Page 46
183	3	Set_2_Pos_Neg_Values	BOOL	See table F Page 46
183	4	Set_2_Control	BOOL	See table F Page 46
184	0	Set_2_Hysteresys	DINT	
188	0	Set_2_Timer	INT	
190	0	Set_2_Delay	INT	
192	0	Monitor_Register	INT	

## WRITING EXAMPLES

To write the set-up parameters following the example:

In the byte 128 (Command Register) write value Hex 7FFF. This value opens the writing area of the DAT 400.

Example: to change the default values of the DAT 400 like the Capacity of the load cells, the Sensitivity and Division value to 15000, 2.9965 and 2:

Capacity	Byte 144	Byte 145	Byte 146	Byte 147
Hex	00	00	3A	98
Dec	15000			

Sensitivity	Byte 148	Byte 149
Hex	75	0D
Dec	29965	

Division	Byte 150	Byte 151
Hex	00	0D
Dec	13	

Save the data by writing the value Hex 20 in Command Register.

N.B. The DAT 400 does not accept writing of the same values already written.

To perform Zero and FS Calibration it is not needed to abilitate the internal Writing Area of the DAT 400.

#### **Zero Calibration:**

Whit empty system put Hex 10 in Command Register (byte 128). The new Zero value is stored.

#### **Full Scale Calibration:**

Put a know weight on the system and write its value in the Data Register (from byte 140 to 143). Put value Hex 11 in Command Register. The weight value will be displayed.

## TROUBLESHOOTING

PROBLEM	POSSIBLE CAUSE	SOLUTION
The display shows the O-L message	The weight is not detectable because the cell is absent or incorrectly connected	Check the connections of the cells.
The display shows the hyphen in the upper display	The weight cannot be shown because it exceeds the available five digits or is greater than the capacity of the cells.	
The display shows the underscore on the lower display.	The weight cannot be shown because negative, more than -9999.	
The number of decimal places is wrong.	Incorrect division value selected.	Select the correct division value in the main menu.
The serial communication does not work properly.	Installation wrong. The selection of the operation of the serial interface is incorrect.	Check the connections as described in the installation manual. Select the settings as appropriate.
The function of semiautomatic zero doesn't work.	The gross weight exceeds the action limit of semi-automatic zero. The weight doesn't stabilize.	To re-establish the zero, calibrate the weight. Wait for the stabilization of the weight or adjust the weight filter parameter.
The semiautomatic tare function does not work.	The gross weight is negative or exceeds the maximum capacity. The weight doesn't stabilize.	Check the gross weight. Wait for the stabilization of the weight or adjust the weight filter parameter.

# EU Declaration of conformity (DoC)

We

Pavone Sistemi S.r.l.  
Via Tiberio Bianchi, 11/13/15  
20863 Concorezzo, MB

**declare that the DoC issued under our sole responsibility and belongs to the following product:**

Apparatus model/Product: **DAT 400**  
Type: Weighing instrument

The object of the declaration described above used as indicated in the installation manual and use, is in conformity with the relevant Union harmonisation legislation:

Directive **EMC 2014/30/EU** Electromagnetic Compatibility

The following harmonized standards and technical specification have been applied:

**EN 61000-6-2:2005**  
**EN 61000-6-3:2007 + A1 2011**

Directive **LVD 2014/35/EU** Low Voltage Directive

The following harmonized standards and technical specification have been applied:

**EN 61010-1:2011**

Signed for end on behalf of:  
Concorezzo: 16/01/2017

Di Reda Donato - Manager



**PAVONE**SYSTEMS

**PAVONE SISTEMI S.R.L.**

Via Tiberio Bianchi 11/13/15, 20863 Concorezzo (MB), ITALY

T 0039 039 9162656 F 0039 039 9162675 W [en.pavonesistemi.it](http://en.pavonesistemi.it)

Industrial Electronic Weighing Systems since 1963

Member of CISQ Federation



CERTIFIED MANAGEMENT SYSTEM  
ISO 9001